

# Educational Furnitures



**EduScience UK**

We Contribute To Future Education  
[www.eduscienceuk.com](http://www.eduscienceuk.com)



## DESIGN IDEAS



## TABLES



## DESKS



## SEATS



## CABINETS



## BOARDS



## LOCKERS



## INNOVATION FURNITURES



## CONFERENCE FURNITURES



## LABORATORY FURNITURES



## CUBICLES

ABOUT ES	4
<b>DESIGN IDEAS</b>	<b>10</b>
<b>TABLES</b>	<b>40</b>
Modular Tables	42
Classroom Tables	52
Group Tables	54
Free Standing Tables	58
<b>DESKS</b>	<b>62</b>
Teacher's Desk	64
Computer Desk	66
Librarian Desk	74
<b>SEATS</b>	<b>78</b>
Chairs & Stools	80
Soft Seats	112

<b>CABINETS</b>	<b>122</b>
Tall Cabinets	124
Medium Cabinets	126
Small Cabinets	128
Wall Mounted Cabinets	129
Arc Cabinets	130
Bookshelves	132
Island Storage	137
Book Trolleys	140
Forest Series	146
Garden Series	150
Colour Series	153
Pixel Series	156
Tetris Series	160
Animal Shelves	162
Imaginarium Series	164
<b>BOARDS</b>	<b>122</b>

<b>LOCKERS</b>	<b>170</b>
Colour Lockers	172
Pigeon Holes	173
Basic Lockers	174
Rainbow Series	178
Giraffe Series	180
Benches & Shelves	182
<b>INNOVATION FURNITURES</b>	<b>184</b>
Collaboration Series	186
Media Workstations	194
Move Series	196
Nest Series	200
Pods	202
Stages	205
Team Benches	208
Workshop Series	210

<b>AUDITORIUM FURNITURES</b>	<b>224</b>
Conference Seats	226
Podiums	229
<b>LABORATORY FURNITURES</b>	<b>234</b>
E Series	236
System 1	240
System 2	244
System 3	250
Student Benches	250
Lab Miscellaneous	256
<b>CUBICLES</b>	<b>264</b>
Basic Cubicle	266
Kids Cubicle	268

EduScience UK Ltd is the leader in design, development, manufacture, supply, installation, and maintenance of furniture, for **EDUCATION, HEALTHCARE** and **OFFICE** sectors, headquartered in the rapidly emerging global trade central, London

All of our furniture is manufactured in our in-house, state-of-the-art facility that houses multiple production sections dedicated to different specializations, evolves over time to include technology that enhances the quality and design of our product. We're always considering new possibilities, sharing ideas, blending technology with materials, and designing new solutions.

At EduScience, we strive to find the new and better solutions for every part of the product development process—from design to production to long-term impact—in cooperation with our valued customers. Our designers leverage an assortment of cutting-edge solutions to manifest ingenious designs precisely tailored for the space.



*Satisfying Customer Needs*



*Continuous Improvement*



*Innovation and Creativity*



*Value For Money*



*Building Relationships*



*Team Synergy*



*Flexibility*

# OUR VISION

*Our vision is to be the leading Medical & Educational solutions provider in the UK and World wide*

- Maximizing opportunities and resources, to overcome the market challenges
- Providing innovative solutions and high quality products backed with comprehensive cost effective services to our medical and educational partners
- Sustaining and continuously improving communication and teamwork among its various functions
- Maintaining win-win partnership and exceeding customer expectation by providing latest innovative technology
- Optimizing the internal structure of the company, on an on-going basis
- Attracting and retaining world class professionals





## Services



### CONSULTATION

Consultation with us is the start of a wonderful dialogue that will establish the needs and desires. Our consultants will guide you toward the best collaborative design and pricing options for you.



### PLANNING

We can provide design and space planning options with drawings and furniture solutions, including colour and equipment concept using the statutory norm .



### VISUALIZATION

Our experienced design team can provide detailed , REALISTIC RENDERINGS using the latest technological equipments to demonstrate interiors for clear communications and predictability.



### ASSEMBLY

All furnitures will be assembled to serve you properly and efficiently, wherever you want .



### DELIVERY

Your furnitures will be delivered to you well packaged. After arranging your furniture we take away all packing for disposal without disrupting your activities.



### MAINTENANCE

In case of larger damage, our professionally trained and experienced staff will take care of the problem .

## Turn Key Projects

Give an empty room to us and we will design & create meaningful learning spaces.

EduScience UK Ltd works in partnership with industry leaders to bring innovative and cutting edge customized solutions including design, supply, installation and preventive maintenance that can be in sync with the school's design concept & theme for all your needs.

Our design team will review your requirements and design a solution which meets the needs of your school. The free space planning service will provide you with detailed plans and drawings of how the environment will flow, look and feel. It's the perfect way to create a perfect environment.

Along with years of experience in designing and installing laboratories to all region, ES is the trusted education supplier to many school in UK. Some of our happy customers include **Ministry of Education, Pvt Academies, Department of Education and Knowledge.**

## Turn Key Projects



ALDAR ACADEMIES



MINISTRY OF EDUCATION  
Dubai, UAE



DELMA SCHOOL



Children grow so fast, we can grow with them. ES provides six size categories with colour coding which you can easily find the right size for different ages. And you can be sure that everyone sitting comfortably at all time regardless of what stage of growth they're currently in.

# WE CAN GROW TOGETHER

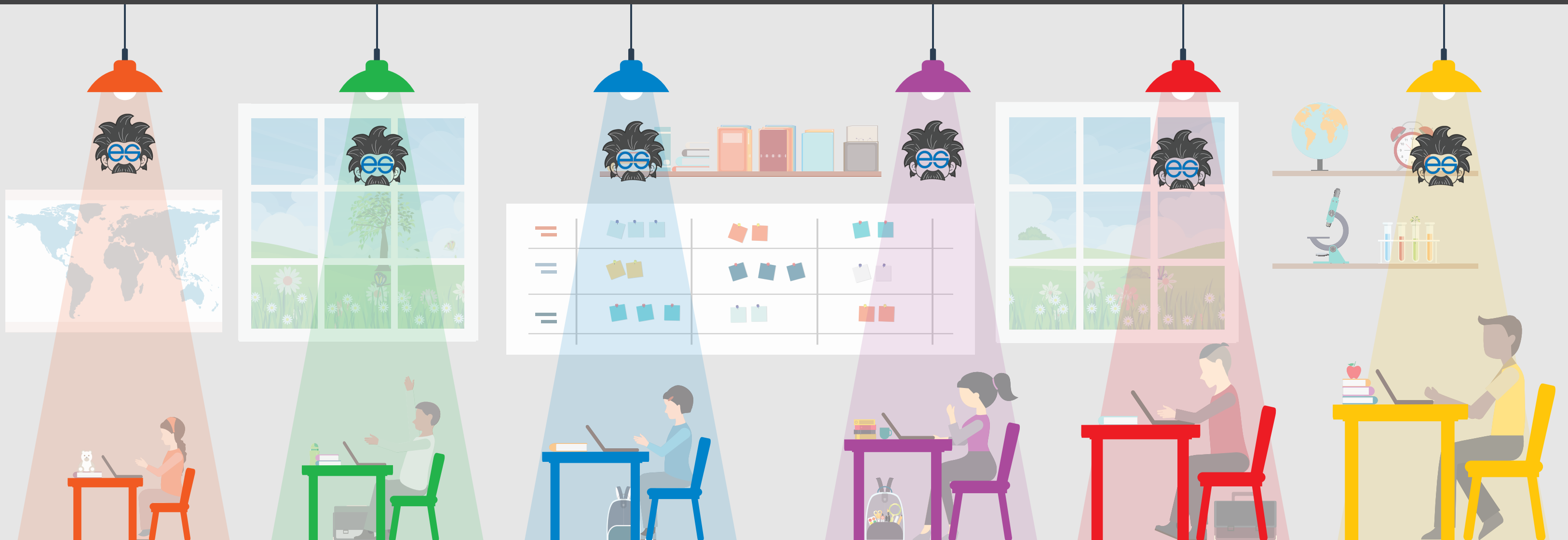

## SIZE 1

Student Age : 4-5 Years  
Table Height : 53 cm  
Seat Height : 31 cm

## SIZE 2

Student Age : 6-7 Years  
Table Height : 59 cm  
Seat Height : 35 cm

## SIZE 3

Student Age : 8-10 Years  
Table Height : 64 cm  
Seat Height : 38 cm

## SIZE 4

Student Age : 11-13 Years  
Table Height : 71 cm  
Seat Height : 43 cm

## SIZE 5

Student Age : 14-18 Years  
Table Height : 76 cm  
Seat Height : 46 cm

## SIZE 6

Student Age : 19-Adult  
Table Height : 82 cm  
Seat Height : 51 cm

DESIGN  
IDEAS

# DESIGN IDEAS





# Multi Media Rooms



The Multi media room is an inspiring creative and interactive learning environment. It is important to include lots of different areas to encourage different styles of learning and support the use of various furniture. Colourful and flexible furniture encourage spontaneous creative thinking and group brainstorming.



Group Work

Team Series

Booth Seat

Slice Table

Media Work Station



Curve Collaboration System

Individual Work









## Learning Resource Centre

The recent move towards the use of mobile devices means learning resource centre now need to be more multifunctional than before. Not only need to provide functional storage for books but also lots of different areas that encourage group work or one to one research with mobile devices.









## Kid's Library

The recent move towards the use of mobile devices means learning resource centre now need to be more multifunctional than before. Not only need to provide functional storage for books but also lots of different areas that encourage group work or one to one research with mobile devices.





# Kindergarten Library



Learning environments of kids needs a flexible layout which can be change easily, places that are capable of accommodating lots of different learning and teaching styles. The library heart of the school where student can meet up socially, creating another flexible space that can accommodate a range of uses.

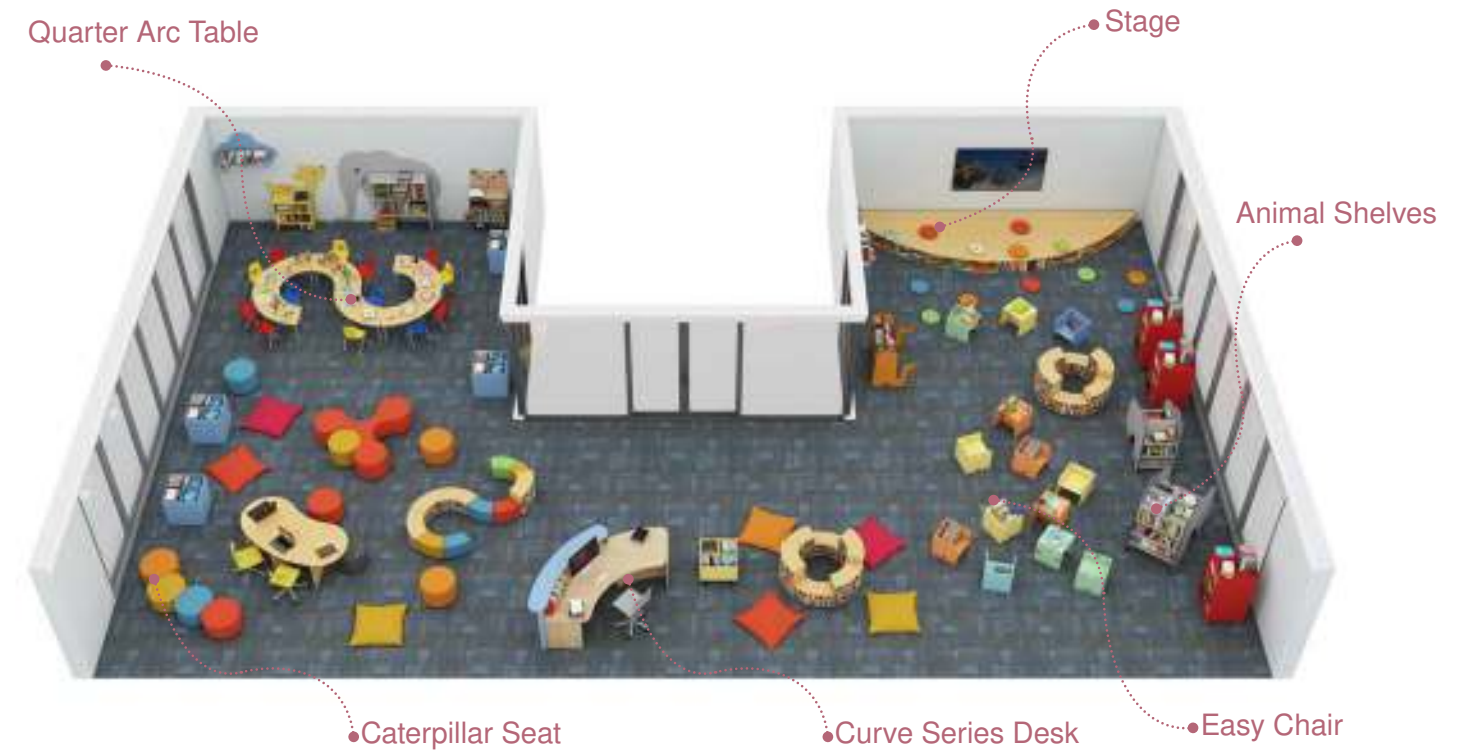





## Fab Lab

A fab lab (fabrication laboratory) is a small-scale workshop offering (personal) digital fabrication. The furnishing idea of Fab Lab is creating a supportive environment and infrastructure for innovation. Equipped With an array of flexible computer-controlled tools that cover several different length scales and various materials, with the aim to make “almost anything” Mobile technology combined with agile furniture can revolutionise how computer science is perceived by students.











## Design Technology Lab

Maker space should be a place where learning comes from hands-on exploration, designing, making, and tinkering. A place of independent, self directed learning that is deeply collaborative and technology enabled. To enable free-reign independence the space has to be well laid out and super-organised.





# MAKER SPACE





# Food Lab

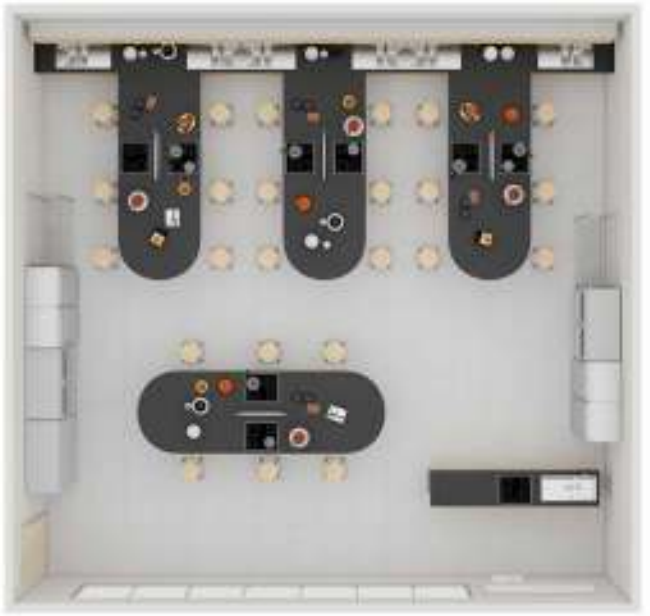

If you are working on a food laboratory project, we can provide an end-to-end solution, from the floor plan design all the way to installing metal lab cabinets, which we manufacture WITH Our approved QC production plant.





# Science Labs

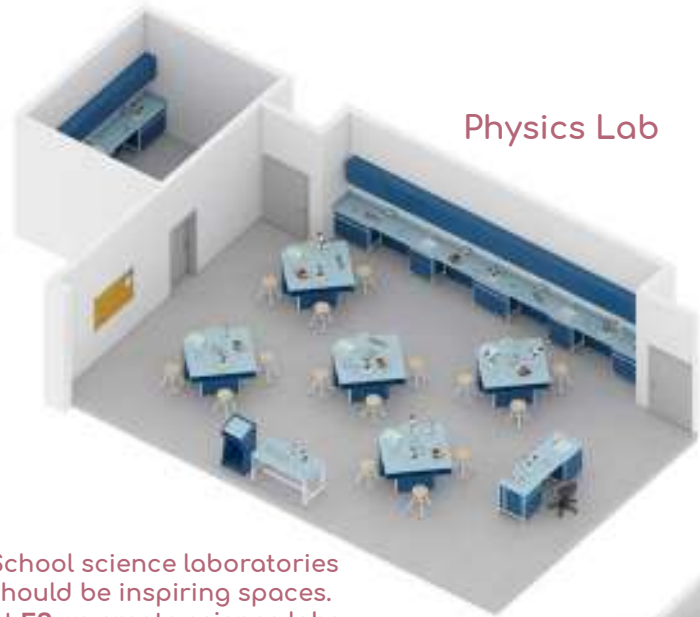

Physics Lab



Chemistry Lab

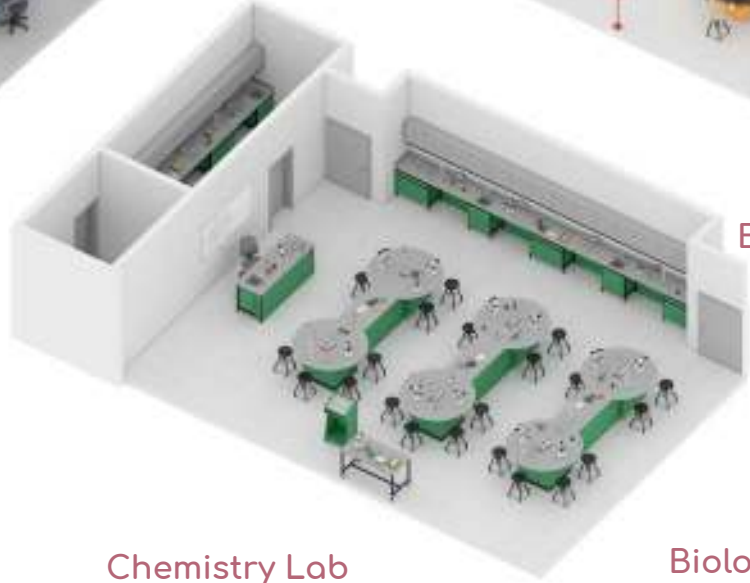

Biology Lab

School science laboratories should be inspiring spaces. At ES we create science labs that will stimulate practical experimentation, interactive learning, group discussion and individual research.

Our team can co-ordinate the supply & installation of your school science laboratory furniture and also offer a full turnkey refurbishment service, if required. This one-stop-shop solution includes the co-ordination of all trades – an invaluable service for busy school staff.

Physics Lab

Chemistry Lab

Biology Lab





# Computer Lab



Modern computer labs need to accommodate a wide range of user needs, changes in technology and regulatory requirements such as ADA compliance. Since 1997, SMARTdesks has provided computer lab furniture for K12 schools, colleges and universities across UK. We offer a wide variety of computer lab workstations and computer lab tables that can be customized around your unique scenario.





Kindergarten Classrooms



• Forest Serie - E061

Varied learning spaces increase creativity and collaboration. mix shapes and colours with multiple configurations to encourage your students to learn where they feel most inspired.



Half Round Tables - E011C

Half ArcTables - E011A





Kindergarten Classrooms



Varied learning spaces increase creativity and collaboration. mix shapes and colours with multiple configurations to encourage your students to learn where they feel most inspired.





# Creative Classrooms

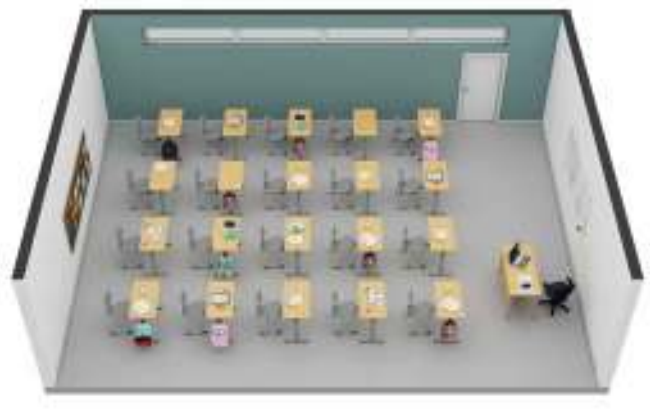

A good learning atmosphere begins with the right environment!





# Modern Classrooms



Modern classrooms are moving away from the traditional classroom layout, in favor of a more flexible set-up, to facilitate collaborative working. Therefore it's important to have a classroom that can be adjusted to fit-in with different types of learning activities.

Rather than being rooted to individual desks in a traditional classroom set-up, students need to be able to move around and gather together where needed. To maximize flexibility, and make it easy to change-up your classroom set-up we can create modern and out of box ideas for your 21st century classrooms.





# Art Classes



From potato prints to clay sculptures and every artistic discipline in between, the art classrooms in our schools require a significant number of tools and materials – all of which need to be stored correctly. At ES we can completely customise the classroom to your requirements. From built in drying racks to ensure a full classes drawings and paintings can be dried to lockable art portfolio storage for student course work – we have developed a range of storage systems to maximise space and allow you to seamlessly deliver lessons throughout the day.





## Cafeteria

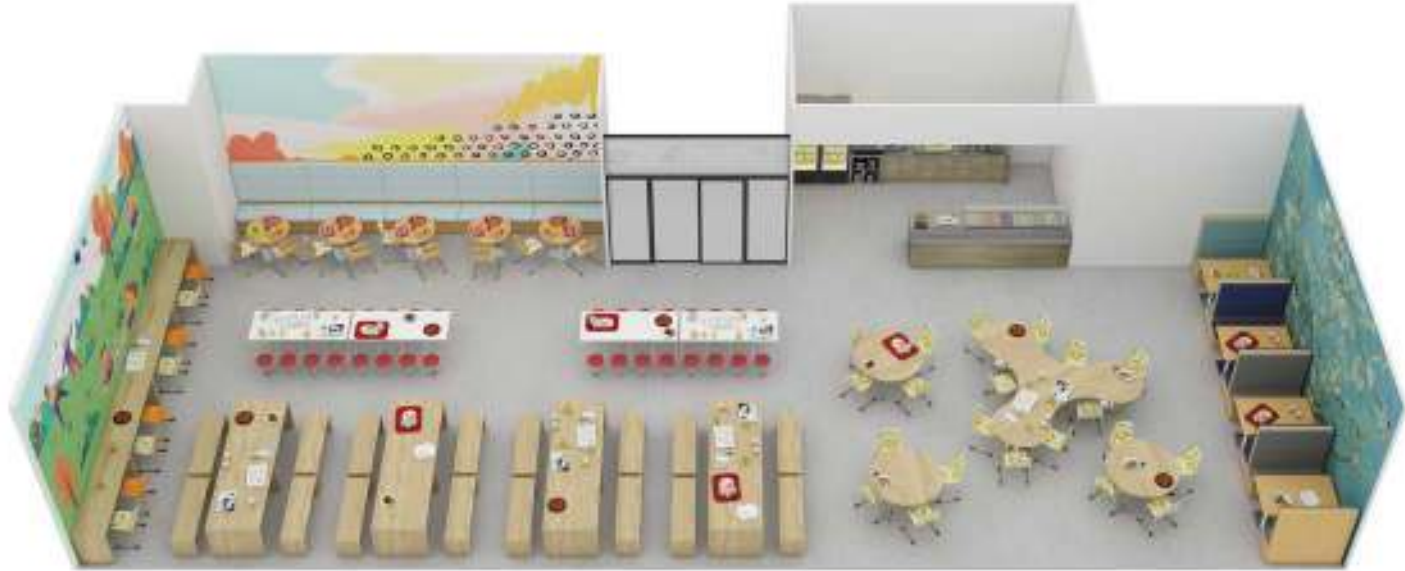

The generous zoning of the room allows for flexible changes and offers plenty of retreat possibilities. Cafeteria is a popular meeting point not just during day but also during evening events. Integrated lounge elements equipped with hygienic washable materials which are extremely resistant.





# TABLES

Modular Tables ..... 42

Classroom Tables .....52

Free Standing Tables .....54

Group Tables. ....58

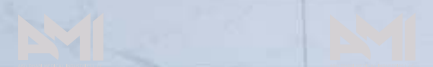



## HALF ARC TABLE

E011A



Half Arc Table have an elegant curvilinear shape that when nested together create visually stimulating collaborative pods. Paired with epoxy coated mild steel tube leg set, these tables offer a stable work surface for the classroom.

- Top available in 18mm thick Laminated Plywood or MDF and 13mm thick Solid Core HPL
- 2mm thick PVC edging for laminated worktop
- Table Height as per requirement



Size:

- E011A1 - 900 mm
- E011A2 - 1000 mm
- E011A3 - 1200 mm



Arrangement Options:



## QUARTER ARC TABLE

E011B



Wildly versatile table is ideal for areas which require both individual study and group work. Arrangements can make big circle groups or flowing lines. Paired with epoxy coated mild steel tube leg set, these tables offer a stable work surface for the classroom.

- Top available in 18mm thick Laminated Plywood or MDF and 13mm thick Solid Core HPL
- 2mm thick PVC edging for laminated worktop
- Table Height as per requirement



Size:

- E011B1 - 1237x500mm
- E011B2 - 1414x500mm
- E011B3 - 1614x500mm

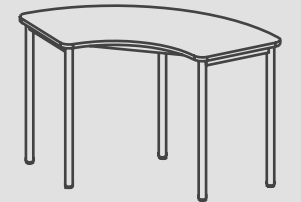

Arrangement Options:





## HALF ARC TABLE

E011C



Half Arc Table provides sleek looks and solid functionality. For group work, combine two to make a circle. Paired with epoxy coated mild steel tube leg set, these tables offer a stable work surface for the classroom.

- Top available in 18mm thick Laminated Plywood or MDF and 13mm thick Solid Core HPL
- 2mm thick PVC edging for laminated worktop
- Table Height as per requirement



Size:

- E011C1 - 900mm length
- E011C2 - 1000mm length
- E011C3 - 1200mm length

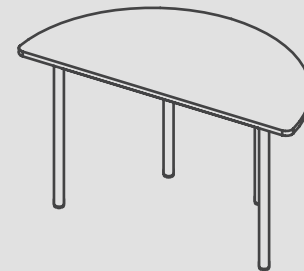

Arrangement Options:



## RECTANGULAR TABLE

E011D



This sleek, contemporary table provides solid functionality. Its large work surface provides ample space for projects and work of all kinds. Paired with epoxy coated, mild steel tube leg set, these tables offer a stable work surface for the classroom.

- Top available in 18mm thick Laminated Plywood or MDF and 13mm thick Solid Core HPL
- 2mm thick PVC edging for laminated worktop
- Table Height as per requirement



Size:

- E011D1 - 900x600mm
- E011D2 - 1000x600mm
- E011D3 - 1200x600mm

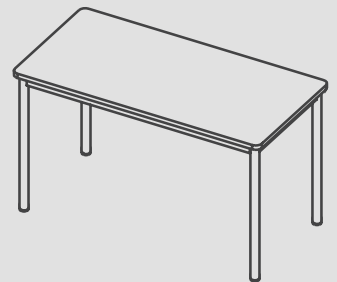

Arrangement Options:

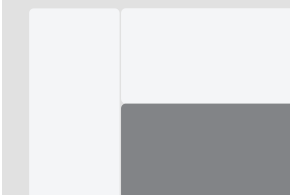



## QUARTER ARC TABLE

E011E



V table is specifically designed to create interactive learning spaces, allowing the user to configure various different shapes by using multiple V tables. Paired with epoxy coated mild steel tube leg set, these tables offer a stable work surface for the classroom.

- Top available in 18mm thick Laminated Plywood or MDF and 13mm thick Solid Core HPL
- 2mm thick PVC edging for laminated worktop
- Table Height as per requirement



Size:

- E011E1 - 1237x500mm
- E011E2 - 1414x500mm
- E011E3 - 1614x500mm

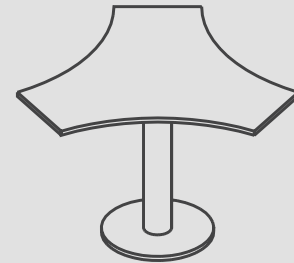

Arrangement Options:



## CRESCENT TABLE

E011F



Crescent table is a fun shape that can be arranged in a variety of creative ways. Use a single Cookie table or join multiple together for a larger footprint collaborative space. Paired with epoxy coated mild steel tube leg set, these tables offer a stable work surface for the classroom.

- Top available in 18mm thick Laminated Plywood or MDF and 13mm thick Solid Core HPL
- 2mm thick PVC edging for laminated worktop
- Table Height as per requirement



Size:

- E011F1 - 900mm Dia
- E011F2 - 1000mm Dia
- E011F3 - 1200mm Dia



Arrangement Options:





## TRAPEZOIDAL TABLE

E011G



This versatile contemporary table provides sleek looks and solid functionality. For group work, combine two to make a hexagon or more to make an big octagon. Paired with epoxy coated mild steel tube leg set, these tables offer a stable work surface for the classroom.

- Top available in 18mm thick Laminated Plywood or MDF and 13mm thick Solid Core HPL
- 2mm thick PVC edging for laminated worktop
- Table Height as per requirement



Size:

- E011G1 - 900x600mm
- E011G2 - 1000x600mm
- E011G3 - 1200x600mm

Arrangement Options:

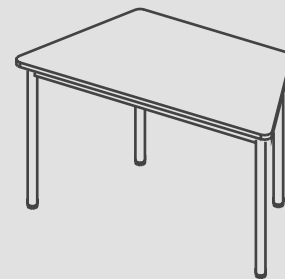
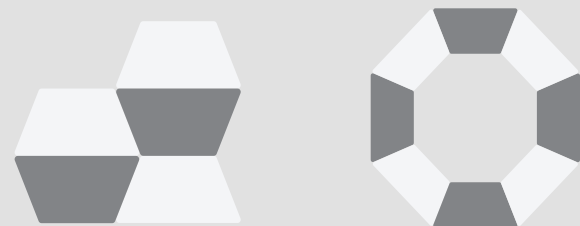

## TRIANGULAR TABLE

E011H



Triangular table provides any number of options for all kinds of new arrangements and set-ups. Paired with epoxy coated mild steel tube leg set, these tables offer a stable work surface for the classroom.

- Top available in 18mm thick Laminated Plywood or MDF and 13mm thick Solid Core HPL
- 2mm thick PVC edging for laminated worktop
- Table Height as per requirement



Size:

- E011H1 - 900x450mm
- E011H2 - 1000x500mm
- E011H3 - 1200x600mm

Arrangement Options:

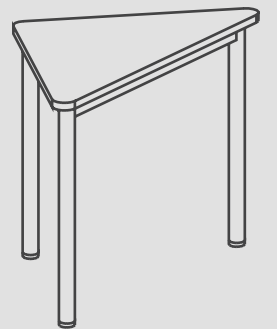
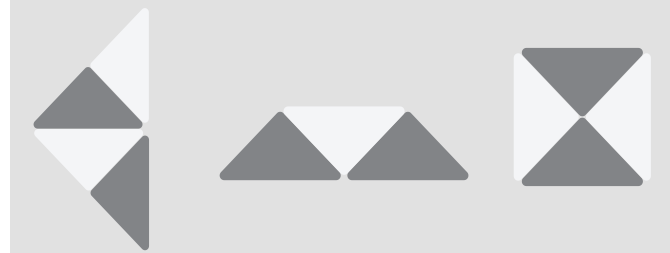



**SLICE TABLE**

E0111



Slice table is a compact design can be use standalone or creates a large circular team table. Paired with epoxy coated mild steel tube leg set, these tables offer a stable work surface for the classroom.

- Top available in 18mm thick Laminated Plywood or MDF and 13mm thick Solid Core HPL
- 2mm thick PVC edging for laminated worktop
- Table Height as per requirement



Size:  
E01111 - 730 x 713mm

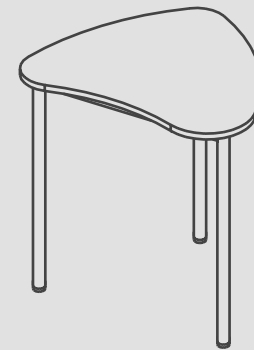

Arrangement Options:

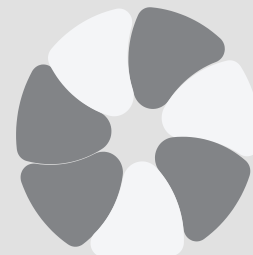



## STUDENT TABLE

E012A



- Top available in 18mm thick Laminated Plywood or MDF and 13mm thick Solid Core HPL
- 2mm thick PVC edging for laminated worktop
- With wired basket under the top
- Structure made with epoxy coated mild steel with glides and end cap
- Table Height as per requirement

Size :  
 E012A1 - 700x500mm  
 E012A2 - 1200x500mm

## 72 SERIES STUDENT TABLE

E012B



- Top 3-layer particleboard surface, melamine coated, Highly abrasion resistant, seamless with 3mm plastic edge, thickness: 25 mm
- Satchel hook right or both sides with 2-seater tables
- Structure made with epoxy coated mild steel with glides and end cap
- Table Height as per requirement

Size:  
 E012B1 - 700x500x760mm  
 E012B2 - 700x500x820mm  
 E012B3 - 1300x500x760mm  
 E012B4 - 1300x500x820mm

## STUDENT TABLE

E012C



- Top from 25mm thick MDF material desk top with melamine with PP injection edge
- With wired basket under the top
- Structure made with epoxy coated mild steel with glides and end cap
- Table Height as per requirement

Size:  
 E012C1 - 700x500x640mm  
 E012C2 - 700x500x760mm  
 E012C3 - 1300x500x640mm  
 E012C4 - 1300x500x760mm

## 7280 SERIES STUDENT TABLE

E012D



- Top, 3-layer particleboard surface, melamine coated, Highly abrasion resistant, seamless with 3 mm plastic edge, thickness: 25 mm
- Both sides with a stacking rack and integrated hooks and stacking buffer
- Structure made with epoxy coated mild steel with glides and end cap
- Table Height as per requirement

Size:  
 E012D1 - 700x500x760mm  
 E012D2 - 700x500x820mm



## 85 SERIES STUDENT TABLE

E012E



- Top 3-layer particleboard surface, melamine coated, Highly abrasion resistant, seamless with 3mm plastic edge, thickness: 25 mm
- Satchel hook right or both sides with 2-seater tables
- With wire basket under the desktop
- Structure made with epoxy coated mild steel with glides and end cap
- Table Height as per requirement

Size:

E012E1 - 700x500x760mm  
E012E2 - 700x500x820mm  
E012E3 - 1300x500x760mm  
E012E4 - 1300x500x820mm

## HORSE SHOE TABLE

E014A



Great for small group instruction and interaction, this contemporary table provides sleek looks and solid functionality. Its work surface provides ample space for projects and work of all kinds. Paired with epoxy coated mild steel tube leg set, these tables offer a stable work surface.

- Top available in 18mm thick Laminated Plywood or MDF and 13mm thick Solid Core HPL
- 2mm thick PVC edging for laminated worktop
- Table Height as per requirement

Size:

E014A1 - 1800x600mm

## ATOM TABLE

E014B



Atom table is an ideal collaborative desk in a flexible learning space. The shape helps students feel comfortable, allowing for more or less personal space, depending on their individual preference. Paired with epoxy coated mild steel tube leg set with round base, these tables offer a stable work surface.

- Top available in 18mm thick Laminated Plywood or MDF and 13mm thick Solid Core HPL
- 2mm thick PVC edging for laminated worktop
- Table Height as per requirement

Size:

E014B1- 2705x2463mm  
E014B2- 3005x2737mm  
E014B3- 3606x3284mm

## BENCH SET

E014C



Bench table is a modern yet practical addition to any collaboration area. Model is featured here along with matching seating.

- Available in 24mm thick Laminated Plywood or MDF or 40mm thick Solid Wood with natural or painted finish
- 2mm thick PVC edging for laminated worktop
- Height as per requirement

Size:

E014C1-TABLE- 1200x900mm  
E014C1-CHAIR- 1100x400mm  
E014C2-TABLE- 1800x900mm  
E014C2-CHAIR- 1700x400mm  
E014C3-TABLE- 2200x900mm  
E014C3-CHAIR- 2100x400mm





## FLOWER TABLE

E014D



Great for small group instruction and interaction, this contemporary table provides sleek looks and solid functionality. Its work surface provides ample space for projects and work of all kinds. Paired with epoxy coated mild steel tube leg set, these tables offer a stable work surface.

- Top available in 18mm thick Laminated Plywood or MDF and 13mm thick Solid Core HPL
- 2mm thick PVC edging for laminated worktop
- Table Height as per requirement

Size:

- E014D1- 900mm dia
- E014D2- 1000mm dia
- E014D2- 1200mm dia

## ROUND TABLE

E014E



Round table designed for collaborative learning provides sleek looks and solid functionality. Paired with epoxy coated mild steel tube leg set, these tables offer a stable work surface.

- Top available in 18mm thick Laminated Plywood or MDF and 13mm thick Solid Core HPL
- 2mm thick PVC edging for laminated worktop
- Table Height as per requirement

Size:

- E014E1- 900mm dia
- E014E2- 1000mm dia
- E014E2- 1200mm dia



## RECTANGULAR TABLE

E013A



- Top available in 12mm thick Solid Surface (Acrylic), 24mm thick Laminated MR MDF, 13mm thick Solid Core HPL
- 2mm thick PVC edging for laminated
- Frame made with round pipe with square base in chrome finish
- Table Height as per requirement

Size:

- E013A1 - 1400x900x750mm
- E013A2 - 1800x900x750mm
- E013A3 - 2400x900x750mm
- E013A4 - 1400x1000x750mm
- E013A5 - 1800x1000x750mm
- E013A6 - 2400x1000x750mm
- E013A7 - 1400x1200x750mm
- E013A8 - 1800x1200x750mm
- E013A9 - 2400x1200x750mm

## ROUND TABLE

E013B



- Top available in 12mm thick Solid Surface (Acrylic), 24mm thick Laminated MR MDF, 13mm thick Solid Core HPL
- 2mm thick PVC edging for laminated
- Frame made with round pipe with round base in chrome finish
- Table Height as per requirement

Size:

- E013B1 - 900mm dia
- E013B2 - 1000mm dia
- E013B3 - 1200mm dia

## SQUARE TABLE

E013C



- Top available in 12mm thick Solid Surface (Acrylic), 24mm thick Laminated MR MDF, 13mm thick Solid Core HPL
- 2mm thick PVC edging for laminated
- Frame made with round pipe with square base in chrome finish
- Table Height as per requirement

Size:

- E013C1 - 900x900x750mm
- E013C2 - 1000x1000x750mm
- E013C3 - 1200x1200x750mm

## D TABLE

E013D



- Top available in 12mm thick Solid Surface (Acrylic), 24mm thick Laminated MR MDF, 13mm thick Solid Core HPL
- 2mm thick PVC edging for laminated
- Frame made with round pipe with square base in chrome finish
- Table Height as per requirement
- Side panel made of 24mm thick laminated MR MDF

Size:

- E013D1 - 1200x900x750mm
- E013D2 - 1800x900x750mm
- E013D3 - 2400x900x750mm
- E013D4 - 1200x1200x750mm
- E013D5 - 1800x1200x750mm
- E013D6 - 2400x1200x750mm



## CAFETERIA UNIT

E011E



Cafeteria Units can serve 25%-40% more students than tables with chairs in the same space. Tables with attached seats eliminate the noise of chairs moving around and banging together. They also eliminate aisle blockage and the 'horseplay' that can occur with chairs.

Available with foldable, movable and different shape and number of seats.

*Please contact with our sales team for more information.*

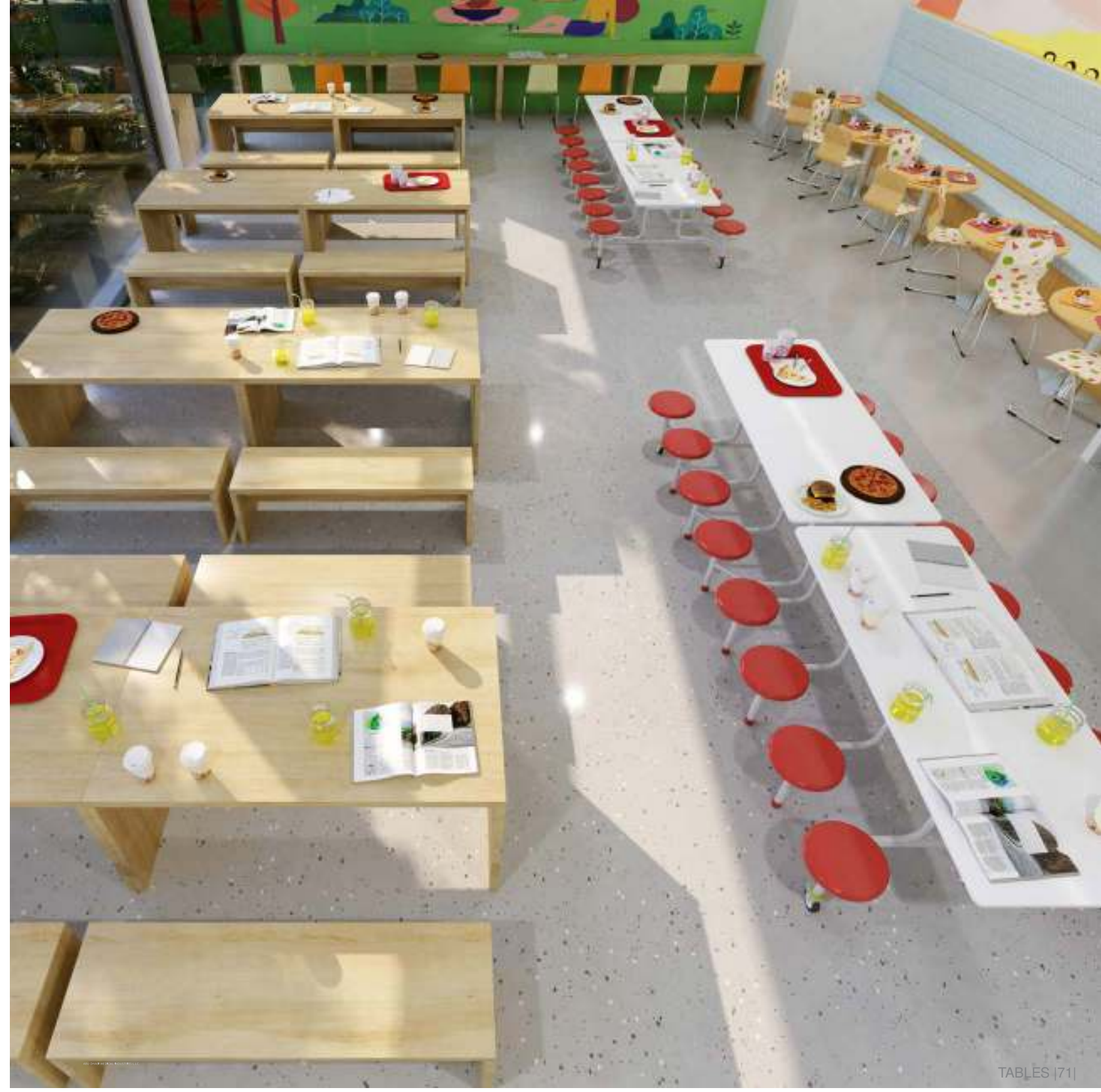



# DESKS

Teacher's Desks..... 64

Computer Desks ..... 66

Librarian Desk ..... 74

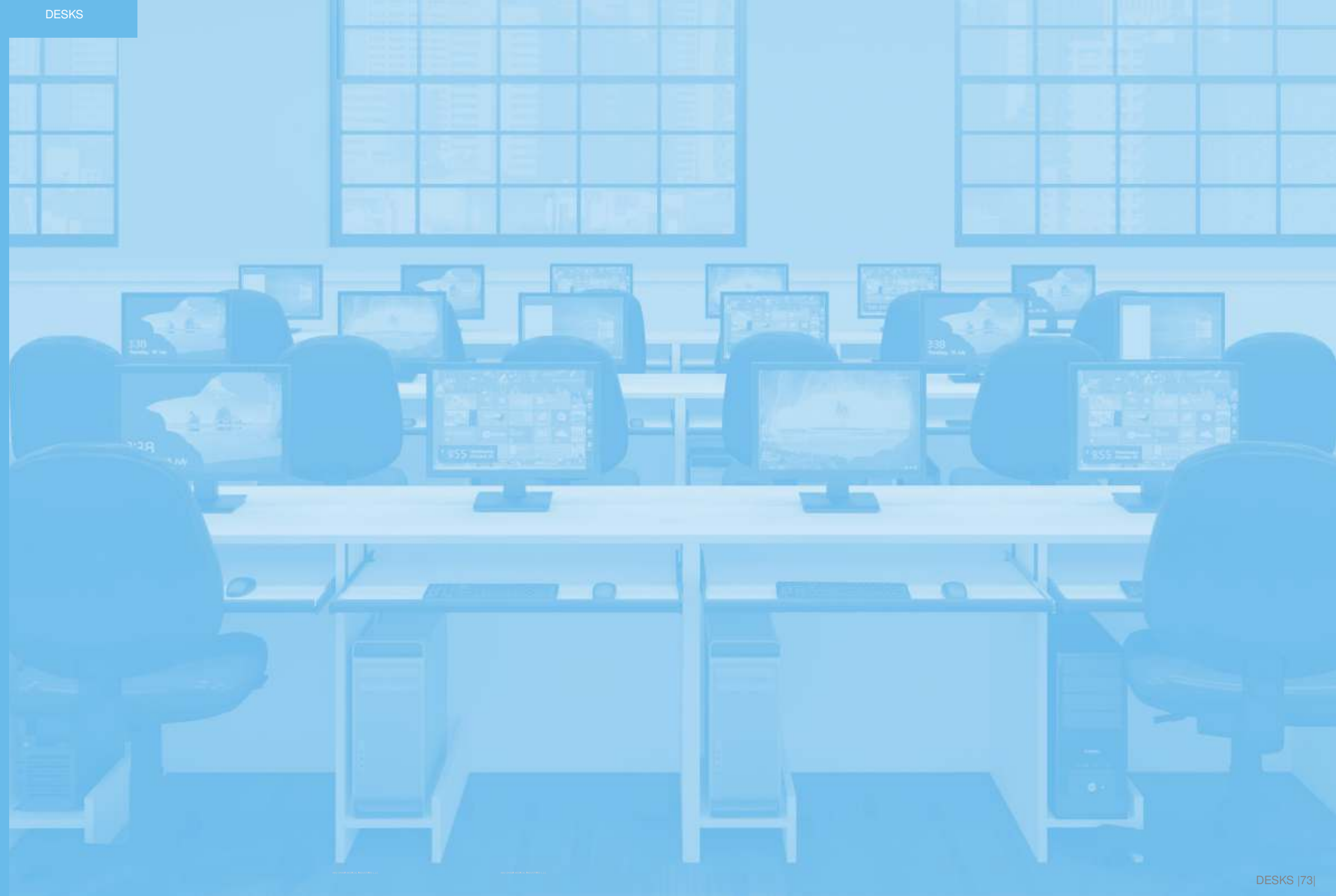



### TEACHER DESK - 1

E021A



- Top available in 12mm thick Solid Surface (Acrylic), 24mm thick Laminated MR MDF, 13mm thick Solid Core HPL
- 2mm thick PVC edging for laminated
- Drawers, cabinets and panels made from laminated plywood or MDF
- Four legged frame from epoxy coated mild steel tube with floor levelling jack

Size:  
E021A1 - 1300x600x760 mm

### TEACHER DESK - 2

E021B



- Top available in 12mm thick Solid Surface (Acrylic), 24mm thick Laminated MR MDF, 13mm thick Solid Core HPL
- 2mm thick PVC edging for laminated
- Drawers, cabinets and panels made from laminated plywood or MDF
- Skid frame from epoxy coated mild steel pipe epoxy coated with glides end cap

Size:  
E021B1 - 1300x600x760 mm

### TEACHER DESK - 3

E021C



- Top available in 12mm thick Solid Surface (Acrylic), 24mm thick Laminated MR MDF, 13mm thick Solid Core HPL
- 2mm thick PVC edging for laminated
- Drawers, cabinets and panels made from laminated plywood or MDF
- Four legged frame from mild steel round pipe welded to mild steel tube with epoxy coating

Size:  
E021C1 - 1300x600x760 mm

### TEACHER DESK - 4

E021D



- Top available highly abrasion resistant melamine coated 3-layer particleboard surface with 19 mm thickness and seamless laser edge
- 2mm thick PVC edging for laminated
- 3-sided panel with storage and side cabinet with lockable 3 drawers made of melamine coated 3-layer particleboard surface with 19 mm thickness and seamless laser edge
- Structure made of epoxy coated mild steel with floor protectors with levelling

Size:  
E021D1 - 1300x650x760 mm



## TEACHER DESK - 5

E012E



- Top available highly abrasion resistant melamine coated 3-layer particleboard surface with 19 mm thickness and seamless laser edge
- 2mm thick PVC edging for laminated
- 3-sided panel with storage and side cabinet with lockable 3 drawers made of melamine coated 3-layer particleboard surface with 19 mm thickness and seamless laser edge
- Structure made of epoxy coated mild steel with floor protectors with integrated impact protection

Size:

E012E1 - 1300x600x760 mm

## COMPUTER DESK - 1

E022A



- Top available in 24mm thick Laminated MDF with PVC edging
- Front panels made from laminated plywood or MDF
- Epoxy powder coated mild steel tube with end cap and with floor levelling jack
- Accesories available as per selection  
CPU Holder, Keyboard Tray, Double Electrical Outlet, Data Outlet, Cable Cover

Size:

E022A1 - 900x600x750mm

E022A2 - 1600x600x750mm

E022A3 - 1600x600x900mm

E022A4 - 2400x600x750mm

## COMPUTER DESK - 2

E022B



- Top available in 24mm thick Laminated MDF with PVC edging
- Front & knee panels made from laminated plywood or MDF
- Epoxy powder coated mild steel tube with end cap and with floor levelling jack
- Accesories available as per selection  
CPU Holder, Keyboard Tray, Double Electrical Outlet, Data Outlet, Cable Cover

Size:

E022B1 - 900x750x750mm

E022B2 - 1600x750x750mm

E022B3 - 1600x750x900mm

E022B4 - 2400x750x750mm





### COMPUTER DESK - 3

E022C



- Top available in 24mm thick Laminated MDF with PVC edging
- Front panels made from laminated plywood or MDF
- Epoxy powder coated mild steel tube with end cap and with floor levelling jack
- Accessories available as per selection  
CPU Holder, Keyboard Tray, Double Electrical Outlet, Data Outlet, Cable Cover

Size:

E022C1 - 900x800x750mm  
E022C2 - 1600x800x750mm  
E022C3 - 1600x800x900mm  
E022C4 - 2400x800x750mm

### FLAT SERIES COMPUTER DESK

E022D



- Structure made of Top available in 24mm thick Laminated MDF with PVC edging
- Mounted CPU holder and Keyboard Tray

Size:

E022D1 - 900x550x750mm  
E022D2 - 1600x550x750mm  
E022D3 - 2400x550x750mm  
E022D4 - 1200x550x750mm

### BOOTH SERIES COMPUTER DESK

E022E



- Structure made of Top available in 24mm thick Laminated MDF with PVC edging
- Outlets, cable cover and trunking units available upon request

Size:

E022E1 - 900x1200x1400mm  
E022E2 - 1780x1200x1400mm  
E022E3 - 2660x1200x1400mm  
E022E4 - 3540x1200x1400mm

### LINEAR SERIES COMPUTER DESK - 1

E022F



- Top available in 24mm thick Laminated MDF with PVC edging
- Privacy panels & shelf available in 18mm thick Laminated MDF with PVC edging
- Epoxy powder coated mild steel tube with end cap and with floor levelling jack
- Outlets, cable cover and trunking units available upon request

Size:

E022F1 - 1200x750x1250mm  
E022F2 - 2400x750x1250mm  
E022F3 - 3600x750x1250mm



## LINEAR SERIES COMPUTER DESK - 2

E022G



- Top available in 24mm thick Laminated MDF with PVC edging
- Privacy panels & shelf available in 18mm thick Laminated MDF with PVC edging
- Epoxy powder coated mild steel tube with end cap and with floor levelling jack
- Outlets, cable cover and trunking units available upon request

Size:  
E022G1 - 1200x1500x750mm  
E022G2 - 2400x1500x750mm  
E022G3 - 3600x1500x750mm

## BASIC SERIES COMPUTER DESK

E022H



- Structure made of Top available in 24mm thick Laminated MDF with PVC edging
- Outlets, cable cover and trunking units available upon request

Size:  
E022H1 - 900x600x750mm  
E022H2 - 1700x600x750mm  
E022H3 - 1400x600x750mm

## COMPUTER DESKS

### COMPUTER DESK - E022A



SIZES:  
E022A1 - 900x600x750mm  
E022A2 - 1600x600x750mm  
E022A3 - 1600x600x900mm  
E022A4 - 2400x600x750mm

### COMPUTER DESK - E022B



SIZES:  
E022B1 - 900x750x750mm  
E022B2 - 1600x750x750mm  
E022B3 - 1600x750x900mm  
E022B4 - 2400x750x750mm

### COMPUTER DESK - E022C



SIZES:  
E022C1 - 900x800x750mm  
E022C2 - 1600x800x750mm  
E022C3 - 1600x800x900mm  
E022C4 - 2400x800x750mm

### FLAT SERIES COMPUTER DESK - E022D



SIZES:  
E022D1 - 900x550x750mm  
E022D2 - 1600x550x750mm  
E022D3 - 2400x550x750mm  
E022D4 - 1200x550x750mm

### FLAT SERIES COMPUTER DESK - E022E



SIZES:  
E022E1 - 900x1200x1400mm  
E022E2 - 1780x1200x1400mm  
E022E3 - 2660x1200x1400mm  
E022E4 - 3540x1200x1400mm

### LINE SERIES COMPUTER DESK-1 - E022F

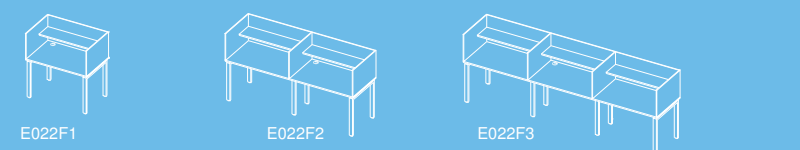

SIZES:  
E022F1 - 1200x750x1250mm  
E022F2 - 2400x750x1250mm  
E022F3 - 3600x750x1250mm

### LINE SERIES COMPUTER DESK-2 - E022G

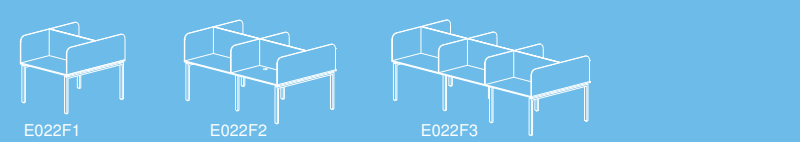

SIZES:  
E022G1 - 1200x1500x750mm  
E022G2 - 2400x1500x750mm  
E022G3 - 3600x1500x750mm

### BASIC SERIES COMPUTER DESK - E022H

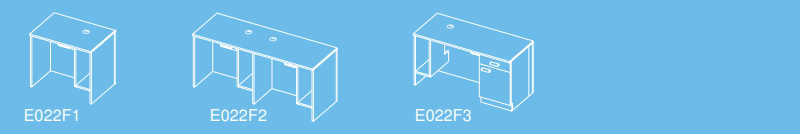

SIZES:  
E022H1 - 900x600x750mm  
E022H2 - 1700x600x750mm  
E022H3 - 1400x600x750mm



## TEAM COMPUTER DESK

E023A



- Top available in 24mm thick Laminated MDF with PVC edging
- Front panels made from laminated plywood or MDF
- Epoxy powder coated mild steel tube with end cap and with floor levelling jack
- Outlets, cable cover and trunking units available upon request

Size:

E023A1 -3600x1200x750mm  
E023A2 -3600x1200x750mm

## FLOWER COMPUTER DESK

E023B



- Top available in 24mm thick Laminated MDF with PVC edging
- Front panels made from laminated plywood or MDF
- Epoxy powder coated mild steel tube with end cap and with floor levelling jack
- Outlets, cable cover and trunking units available upon request

Size:

E023B1 - 2281x1985x750mm

## BOLUS COMPUTER DESK

E023C



- Top available in 24mm thick Laminated MDF with PVC edging
- Front panels made from laminated plywood or MDF
- Epoxy powder coated mild steel tube with end cap and with floor levelling jack
- Outlets, cable cover and trunking units available upon request

Size:

E023C1 -1500x1200x750mm  
E023C2 -2400x1200x750mm  
E023C3 -3000x1200x750mm

## ARC COMPUTER DESK

E023D



- Top available in 24mm thick Laminated MDF with PVC edging
- Front panels made from laminated plywood or MDF
- Epoxy powder coated mild steel tube with end cap and with floor levelling jack
- Outlets, cable cover and trunking units available upon request

Size:

E023D1 -2600x900mm  
E023D2 -1800x900mm



### LIBRARIAN COUNTER

E024A



- Top available in 12mm thick Solid Surface (Acrylic), 24mm thick Laminated MR MDF, 13mm thick Solid Core HPL
- 2mm thick PVC edging for laminated
- Drawers, cabinets and panels made from laminated plywood or MDF
- Four legged frame from epoxy coated mild steel tube with floor levelling jack
- CPU holder & cable cover available upon request

Size:  
E024A1 -1800/2000x800x750mm

### LIBRARIAN DESK

E024B



- Top available in 12mm thick Solid Surface (Acrylic), 24mm thick Laminated MR MDF, 13mm thick Solid Core HPL
- 2mm thick PVC edging for laminated
- Drawers, cabinets and panels made from laminated plywood or MDF
- Four legged frame from epoxy coated mild steel tube with floor levelling jack
- CPU holder & cable cover available upon request

Size:  
E024B1 - 2400x800x750mm

### WALL MOUNTED SEARCH STATION

E024C



- Structure made of 18mm thick Laminated MDF with PVC edging
- Epoxy coated perforated mild steel side panel
- Cable cover units available upon request

Size:  
E024C1 -600x500x600mm

### FREE STANDING SEARCH STATION

E024D



- Structure made of 18mm thick Laminated MDF with PVC edging
- Epoxy coated perforated mild steel side panel
- Cable cover units available upon request

Size:  
E024D1 - 600x1000x1200mm



**CURVE SERIES**

E024E



- Top available in 24mm thick Laminated MDF with PVC edging
- Front panels made from laminated plywood or MDF
- Epoxy powder coated mild steel tube with end cap and with floor levelling jack
- Outlets, cable cover and trunking units available upon request

Size:

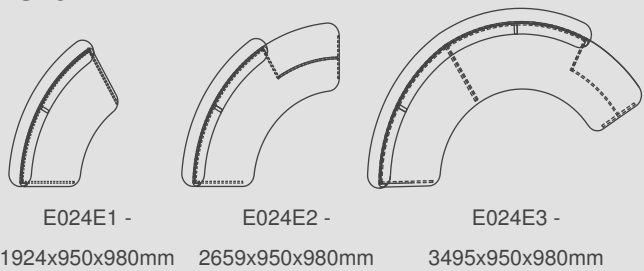



# SEATS

Chairs & Stools..... 80

Soft Seating.....112





**ES CHAIR**

E024A



E024B



Size:  
E024A1 -1800/2000x800750mm

Size:  
E024A1 -1800/2000x800750mm



**ESKIDS CHAIR**

E024C



E024D



Size:  
E024A1 -1800/2000x800750mm





**FLEX**

E033I1



- Ergonomically shaped plastic pan made from robust recyclable polypropylene in 7 attractive colours
- Inverse sitting, saddle sitting and casual sitting are also supported by the shape
- Easy to clean thanks to the special a2s surface structure
- Channel for venting and relieving back strain
- Finger hole in the lumbar region, handles to the top back edge and underside of the chair
- Flex with the globally patented Z-shape frame, optional cross brace for even more stability



supports muscle tone with its ergonomic shape and promotes variable, anti-tiring sitting, e.g. saddle seats.



Seat pan with integrated air ducts without holes which prevents soiling to the inner shell and mildew.



A2S floorsafe® floor protectors protect the flooring even if the chair is wobbled, patent # 10 2010 039 292 A1



C-shape with A2S floorsafe® floor protectors, can be hung on tables

4-leg with writing tablet

stacks 5 chairs high

C-shape with cushioning

with gas-lift

with spindle

MODEL	7874	7853	7854	7876 / 7873	7875
Powder-coated frame	4-leg	Z-shape	C-shape	Gas-lift I / II	Spindle
Star base				Aluminium	Aluminium
Size	2-7	2-7	2-7	3-5 / 5-7	5-7
Adjustable height				33-43 / 41-54 cm	44-52 cm
Weight - Size 6	5,4 kg	6,7 kg	5,8 kg	7,4 kg	7,25 kg
Stacking capacity	5 items	3 items	4 items		



81 SERIES



- Seat and back made from sturdy plastic, recyclable
- extra stable thanks to a welded oval tube 35/15/2, scratch-resistant powder coating
- available in sizes 3–7
- can be hung on tables





## 78 SERIES



## 78 SERIES





**72 SERIES**



- Ergonomically shaped plastic pan made from robust recyclable polypropylene in 7 attractive colours
- Inverse sitting, saddle sitting and casual sitting are also supported by the shape
- Easy to clean thanks to the special a2s surface structure
- Channel for venting and relieving back strain
- Finger hole in the lumbar region, handles to the top back edge and underside of the chair

MODEL	7200 / 7205	3305	7307	8346 / 8386	7846
Powder-coated frame	Chair with glides	4-leg	C-shape	Gas-lift I / II	Spindle
Star base				Aluminium	Steel
Size	2-7 / E	E	2-7, E	3-5 / 6-7	5-7
Adjustable height				31-42 / 41-56 cm	40-58 cm
Weight - Size 6	4,9 kg	4,4 kg	4,9 kg	6 kg	6,2 kg
Stacking capacity without upholstery - Size 6	15 items	15 items	9 items		





## PAGHOLZ COLOUR WOOD

The impressive features of Pagholz® are also available in 5 attractive colours. The natural, warm structure of the beech wood remains intact. The coloured surface is, of course, scratch- and impact-resistant as usual. The environmentally-friendly staining process developed by A2S can be done with all Pagholz pans with all available frames. Pagholz® colour wood is ideal for combining with our upholstery fabrics, too.



## PAGHOLZ COLOUR

You can add a splash of colour to all our Pagholz pans with Pagholz® colour. The colour is completely opaque and long-lasting when applied to the surface and enhances the natural delicacy of the seat pan. Due to the high levels of stress to the seat, we only offer Pagholz colour with seat cushions. From just 20 chairs per order, any Pagholz pan with all available frames comes in the standard colours Satin Matte Black and White. Should you want a custom colour, please speak to your A2S adviser.



## PAGHOLZ FABRIC FINISH

Printed fabrics with visible textile structure on the front of the Pagholz pans lend the chair a personal touch and bring an individual feel-good atmosphere to any room. The fabric surface is sealed with melamine resin. This results in a smooth, sealed surface. The chair can be cleaned and is, as usual with Pagholz®, scratch- and impact-resistant. Fabric finishes can be added to seat pans in the 72 Series as well as to the Woodplac® seat and back sets. Choose from 5 designs that we always have available or design your own pattern – just speak to your A2S adviser.

**FABRIC FINISHES**

1. Cow Print 220
2. Floral 220
3. Abstract 220
4. City 220
5. Floral 220

## 71 SERIES



- Ideal for small rooms with limited space as there are no chair legs to get in the way when entering and leaving
- Extremely robust and durable thanks to the solid wood design
- Stable welded oval tubing made from 2 mm thick tubular steel, scratch-resistant thanks to powder coating
- Highly scratch-resistant wooden surfaces thanks to our unique woodplac melamine coating (models 7100, 7130, 7132)
- Concealed fixings to seat and back protect against injuries and enable rapid removal and replacement



variable and durable: seat and back are secured with concealed screws or rivets.

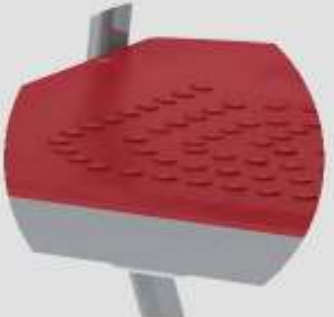

Anti-slip seating with embossed dimples on fittings with Woodplac wood elements



ABS floor protectors are gentle on the flooring, protect the chair legs from scratches and are easy to replace



with writing tablet



with upholstered seat and back



stacks 5 chairs high



3-position height adjustment



MODEL	7110	7100	7130 / 7132
Finish	Multiplex Seat without dimples	Woodplac Seat with dimples	Woodplac Seat with dimples
Powder-coated frame	C-shape	C-shape	height adjustable
Size	2-7	2-7	3-5 / 5-7
Adjustable height			34-42 / 42-50 cm
Weight - Size 6	6,7 kg	6,7 kg	6,2 kg / 11,3 kg
Stacking capacity without upholstery - Size 6	5 items	5 items	3 / 4 items



## SWIVEL CHAIR



- 5-arm frame with plastic floor protectors or with load-dependent braking double safety castors
- Concealed back fixings protect against injury and enables fast replacement of the wooden elements



### SWIVEL CHAIRS



MODEL	8342 / 8382	7950
FINISH	Woodplac Seat with dimples	Woodplac Seat with dimples
Powder-coated frame	Gas-lift 1 / 11	Spindle
Powder-coated star base	Aluminium	Steel
Size	3-5 / 5-7	5-7
Adjustable height	31-42 cm / 41-56 cm	40-58 cm
Weight	7.4 kg / 8.6 kg	8.8 kg

## 'BASIC' SWIVEL CHAIR



- Free height adjustment from 42-54 cm by gas-lift with shock-absorption
- Synchronised mechanism with single-lever adjustment
- Upholstered seat and back, cover as on a2s fabric chart
- Back with a permanent connection mechanism and integrated lumbar support as well as load-dependent back and
- Seat tilt adjustment
- 5-Arm powder-coated aluminium die-cast frame with load-dependent braking castors 50 mm double safety castors
- Optional height-adjustable armrests



Plastic seat pan as edge guard with contoured seat for comfortable sitting



Back and seat tilt can be freely adjusted and tilted



MODEL	9340
Black aluminium die-cast star base	Gas-lift
Adjustable height	42-54 cm
Weight	15 kg

**7470 SERIES**



even with seat upholstery,  
can be stacked up to 10 chairs high  
vertically with stacking rack



optional row linking system,  
emergency interlock



- Stacks up to 10 chairs vertically
- Micro-alloyed, 20/1.5 Mm thick chromed tubular steel
- Solid beech multiplex pan, painted with environmentally-friendly water-based paint, available with scratch- and impact-resistant cpl coating
- Available with seat and back upholstery

MODEL	7470.003	7470.004
Chrome frame	4-leg	4-leg
Size	6	6
Weight	5.4 kg	5.4 kg
Stacking capacity (also with upholstery)	10 items	10 items





with seat and back upholstery,  
available in many colours

available in many fresh colours





with punched handle  
and ventilation holes

with seat upholstery  
in many attractive colours

Stacking trolley  
for fast and easy transport



**74 SERIES | STRAIGHT MULTIPLEX PAN**



- ergonomic seat pan with concealed fixings
- made from solid beech Multiples, painted with environmentally-friendly water-based paint
- micro-alloyed, 20/1.5 mm thick chromed tubular steel
- One pan – lots of options:
- The 74 Series is suitable for all areas and purposes with its variety of different pan colours with seat and/or back upholstery and three frame variants.



MODEL	7470.008	7819	8339 / 8379
Frame	4-leg	C-shape	Gas-lift I / II
Star base			Aluminium
Size	6	67	3-5 / 5-7
Adjustable height			31-42 cm / 41-56 cm
Weight · Size 6	5.4 kg	6.1 kg	7 kg
Stacking capacity · Size 6	10 items	9 items	

## 74 SERIES | ROUND/TAPERED MULTIPLEX PAN



available with seat and back upholstery

Round beech Multiplex pan with 4-leg frame in many attractive colours, available with kidney shaped handle hole

4-leg chairs in both models can stack up to 10 (!) chairs vertically even with upholstery

- classic seat pan shapes for all kinds of uses
- made from solid beech Multiplex, painted with environmentally-friendly water-based paint
- micro-alloyed, 20/1.5 mm thick chromed tubular steel
- also available with seat and back upholstery



available with seat and back upholstery

Tapered beech Multiplex pan with a 4-leg frame, available with trapeze-shaped handle hole



MODEL	7470.009	7822	8338 / 8378	7470.005	7818	8337 / 8377
Frame	4-leg	C-shape	Gas-lift I / II	4-leg	C-shape	Gas-lift I / II
Star base			Aluminium			Aluminium
Size	6	2-7	3-5 / 5-7	6	2-7	3-5 / 5-7
Adjustable height			31-42 cm / 41-56 cm			31-42 cm / 41-56 cm
Weight - Size 6	5,4 kg	5,5 kg	7 kg	5,4 kg	5,5 kg	7 kg
Stacking capacity without upholstery - Size 6	10 items	9 items		10 items	9 items	



7097 | SOLID WOOD CHAIR



- Seat and back made from solid beech Multiplex
- Frame in solid beech wood
- environmentally-friendly seal with water-based paint
- durable thanks to pegged, glued and bolted joints
- stacks up to 6 chairs high



7000 | SOLID WOOD CHAIR



- Sturdy two-column structure made from solid beech wood, mortised and pegged
- Frame, seat and back painted with environmentally-friendly water-based paint
- Seat and backrest made from beech multiplex available in 6 optional vibrant colours

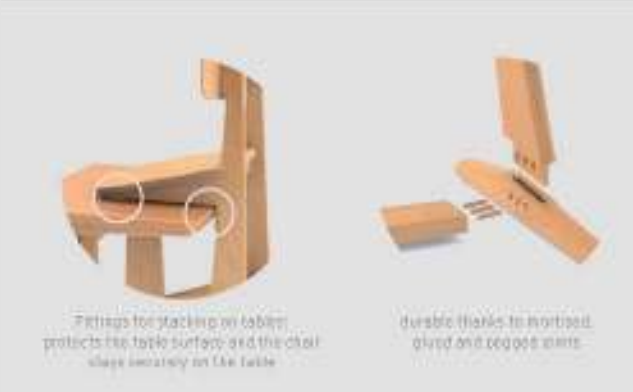

<b>MODEL</b>	<b>7000</b>
Natural painted beech frame	Skid-base chair
Size	2-7
Weight · Size 6	5.8 kg

'BASIC' CONFERENCE CHAIR



- Free height adjustment from 42-54 cm by gas-lift with shock-absorption
- Synchronised mechanism with single-lever adjustment
- Upholstered seat and back, cover as on a2s fabric chart
- Back with a permanent connection mechanism and integrated lumbar support as well as load-dependent back and
- Seat tilt adjustment
- 5-Arm powder-coated aluminium die-cast frame with load-dependent braking castors 50 mm double safety castors
- Optional height-adjustable armrests



<b>MODEL</b>	<b>9261.001</b>	<b>9260.001</b>
Powder-coated frame	C-shape	4-leg
Stacking capacity	-	5 items
Weight	8 kg	7 kg



### 'COMFORT' SWIVEL CHAIR



- Height freely adjustable from 42-53 cm with gas-lift, with shock-absorption thanks to synchronising
- Mechanism with single-lever adjustment
- With comfortable full upholstery, cover as on a2s fabric chart or with black mesh back for good ventilation
- Adjustable body weight and comfort settings as well as backrest contact pressure from 45–120 kg
- Seat tilt and seat depth individually adjustable
- Raised backrest with height adjustment



optional 3D armrests that can be adjusted for height, width and depth and swivel



Back and seat can be adjusted to many positions e.g. with freely adjustable-tilting seat



5-arm polished aluminium base with load-dependent braking double safety 60 mm castors

### 'BASIC' CONFERENCE CHAIR



Back with upholstery, with natural beech armrests

Back with mesh - adapts to the body and provides good ventilation



<b>MODEL</b>	<b>9322.001</b>	<b>9323.001</b>	<b>MODEL</b>	<b>9264.001</b>	<b>9265.001</b>
Back	Upholstery	Mesh	Back	Upholstery	Mesh
Polished aluminium die-cast star base	Gas-lift	Gas-lift	Powder-coated frame	C-shape	C-shape
Adjustable height	43-53 cm	43-53 cm	Weight	13 kg	13 kg
Weight	16 kg	16 kg			

**'COMFORT' SWIVEL CHAIR**



- Pagholz® pan: especially slim design making it flexible and still unbreakable
- Free height adjustment from 42-51 cm by gas-lift with shock-absorption
- Synchronised mechanism with single-lever adjustment
- Seat tilt mechanism with weight adjustment, 0° tilt – 18° lockable in 5 settings
- 5-Arm, polished aluminium die-cast frame with load-dependent braking double safety castors
- Optional: with seat and back upholstery in leather or fabric with retractable armrests in pagholz®



9335 - optional leather seat and back upholstery

9335 - optional armrests

ergonomically shaped, flexible Pagholz pan, optional adjustable armrests

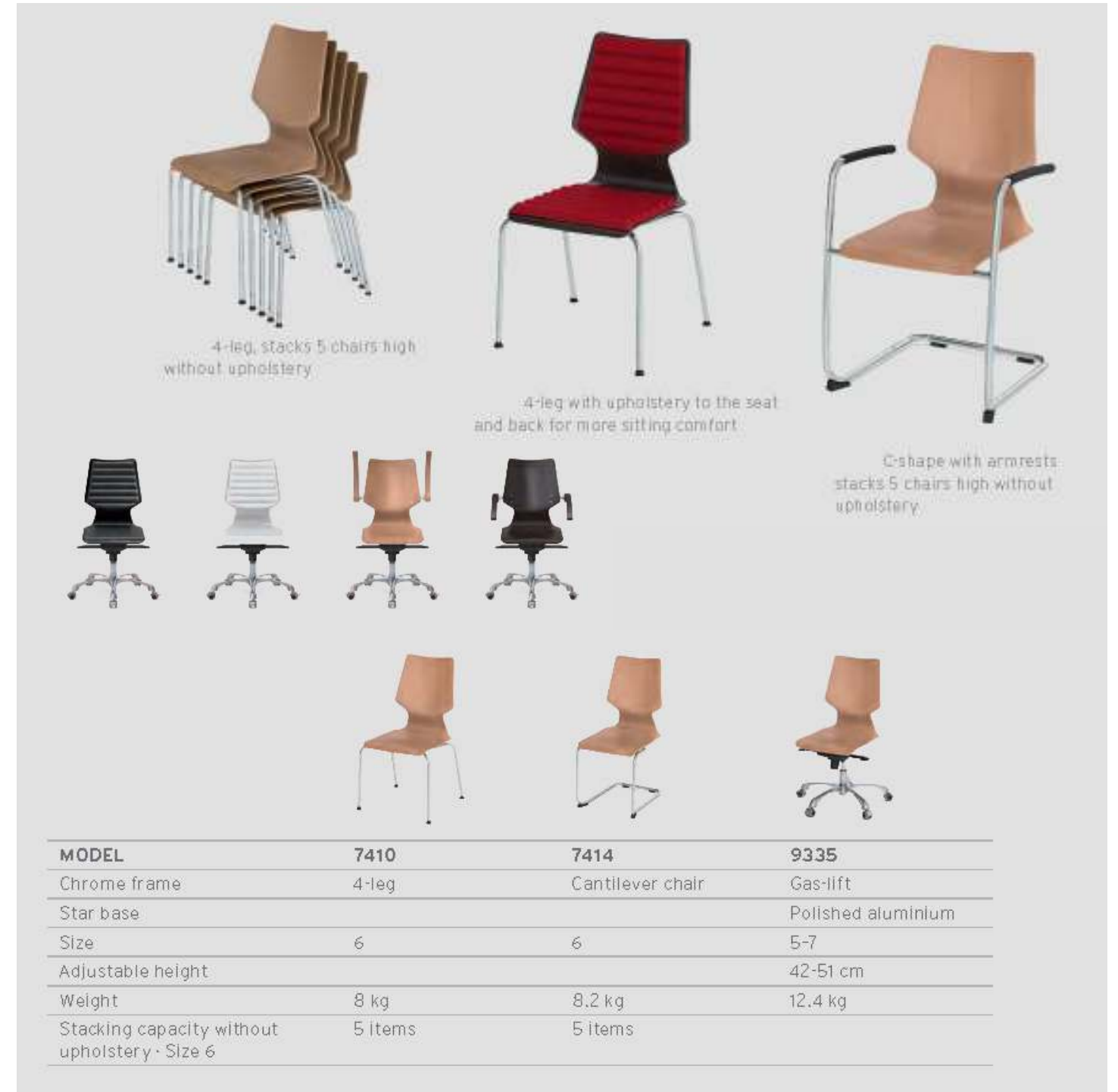

4-leg, stacks 5 chairs high without upholstery

4-leg with upholstery to the seat and back for more sitting comfort

C-shape with armrests stacks 5 chairs high without upholstery

MODEL	7410	7414	9335
Chrome frame	4-leg	Cantilever chair	Gas-lift
Star base			Polished aluminium
Size	6	6	5-7
Adjustable height			42-51 cm
Weight	8 kg	8,2 kg	12.4 kg
Stacking capacity without upholstery · Size 6	5 items	5 items	



## STOOLS

E032B1



- Stool made of powder coated mild steel legs, rubber shoes at bottom and rectangular seat of 30mm thick plywood with teak veneer varnish
- Adjustable height from 570mm to 720mm high with threaded mechanism.
- Legs have tubular bracing at the bottom with leg rest foot ring

Size:  
E032B1 - 470x350mm

E032B2



- Stool made of powder coated mild steel legs, rubber shoes at bottom and rectangular seat of 30mm thick plywood with teak veneer varnish
- Adjustable height from 570mm to 720mm high with threaded mechanism.
- Legs have tubular bracing at the bottom with leg rest foot ring

Size:  
E032B2 - 350mm dia

## EASY CHAIR

E031L



- Easy chair is a multifunctional object that can be used as a chair or table.
- Available in 18mm thick laminated plywood or MDF, solid wood with veneer or painted options

Size:  
E031L1- 450x450x450mm

## CONNECT SOFT SEAT

E033A



- Upholstered in a durable PVC or Fabric finish with high density foam provides seating comfort.
- Special design allows to combine to create different combinations with multiple items

Size:  
E033A1 - 1330x1210x350mm  
E033A2 - 1330x1210x350mm

### CATERPILLAR SOFT SEAT

E033B



- Upholstered in a durable PVC or Fabric finish with high density foam provides seating comfort.
- Special design allows to combine to create different combinations with multiple items

Size:  
E033B1 - 600mm dia x 350mm height  
E033B2 - 600mm dia x 460mm height

### HONEYCOMB SOFT SEAT

E033C



- Upholstered in a durable PVC or Fabric finish with high density foam provides seating comfort.
- Special design allows to combine to create different combinations with multiple items

Size:  
E033C1 - 600mm dia x 350mm height  
E033C2 - 600mm dia x 460mm height





## RECTANGULAR SOFT SEAT

E033D



- Upholstered in a durable PVC or Fabric finish with high density foam provides seating comfort.
- Special design allows to combine to create different combinations with multiple items

Size:

E033D1 - 450x450x350mm  
 E033D2 - 450x450x460mm  
 E033D3 - 900x450x350mm  
 E033D4 - 900x450x460mm  
 E033D5 - 1200x450x350mm  
 E033D6 - 1200x450x460mm

## ROUND SOFT SEAT

E033E



- Upholstered in a durable PVC or Fabric finish with high density foam provides seating comfort.
- Special design allows to combine to create different combinations with multiple items

Size:

E033E1 - 450mm dia x 350mm height  
 E033E2 - 450mm dia x 460mm height  
 E033E3 - 900mm dia x 350mm height  
 E033E4 - 900mm dia x 460mm height  
 E033E5 - 1200mm dia x 350mm height  
 E033E6 - 1200mm dia x 460mm height

## ARC SOFT SEAT

E033F

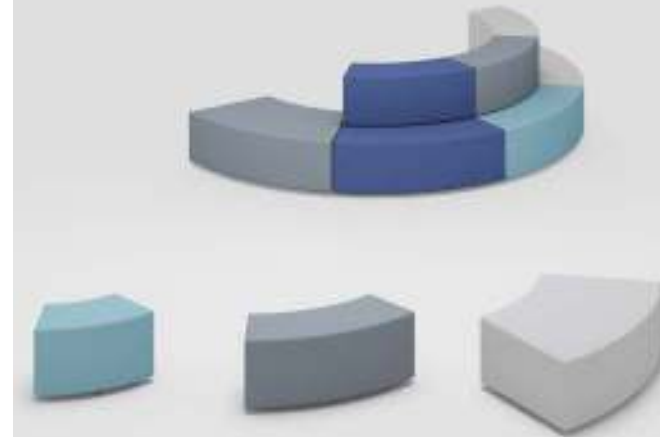

- Upholstered in a durable PVC or Fabric finish with high density foam provides seating comfort.
- Special design allows to combine to create different combinations with multiple items

Size:

E033F1 - 857x450x350mm  
 E033F2 - 857x450x460mm  
 E033F3 - 1263x450x350mm  
 E033F4 - 1263x450x460mm  
 E033F5 - 1607x900x350mm  
 E033F6 - 1607x900x460mm

## PRISM SOFT SEAT

E033G

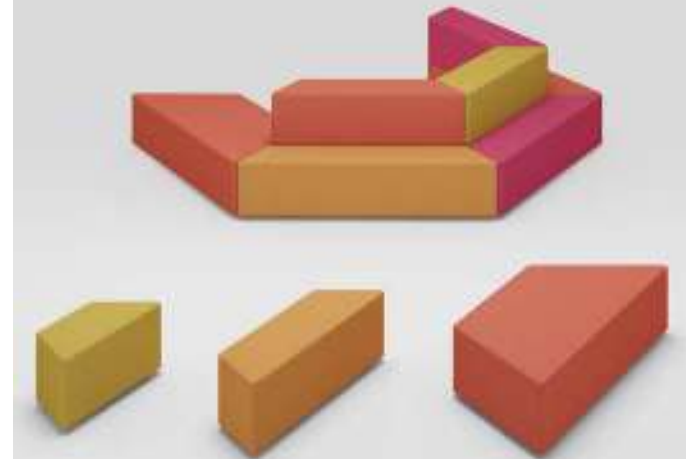

- Upholstered in a durable PVC or Fabric finish with high density foam provides seating comfort.
- Special design allows to combine to create different combinations with multiple items

Size:

E033G1 - 1108x450x350mm  
 E033G2 - 1108x450x460mm  
 E033G3 - 1720x450x350mm  
 E033G4 - 1720x450x460mm  
 E033G5 - 2239x900x350mm  
 E033G6 - 2239x900x460mm

## BOOTH SEAT



- Panels available in 18mm thick MDF or Plywood with laminate or paint options
- Upholstered in a durable PVC or Fabric finish with high density foam provides seating comfort.

Size:  
E012H1 - 700x550x1500mm -SINGLE SIDE  
E012H2 -1400x550x1500mm -SINGLE SIDE  
E012H3 - 700x1000x1500mm -DOUBLE SIDE  
E012H1 - 1000x1000x1500mm -DOUBLE SIDE





### TETRIS SERIES SOFT SEAT

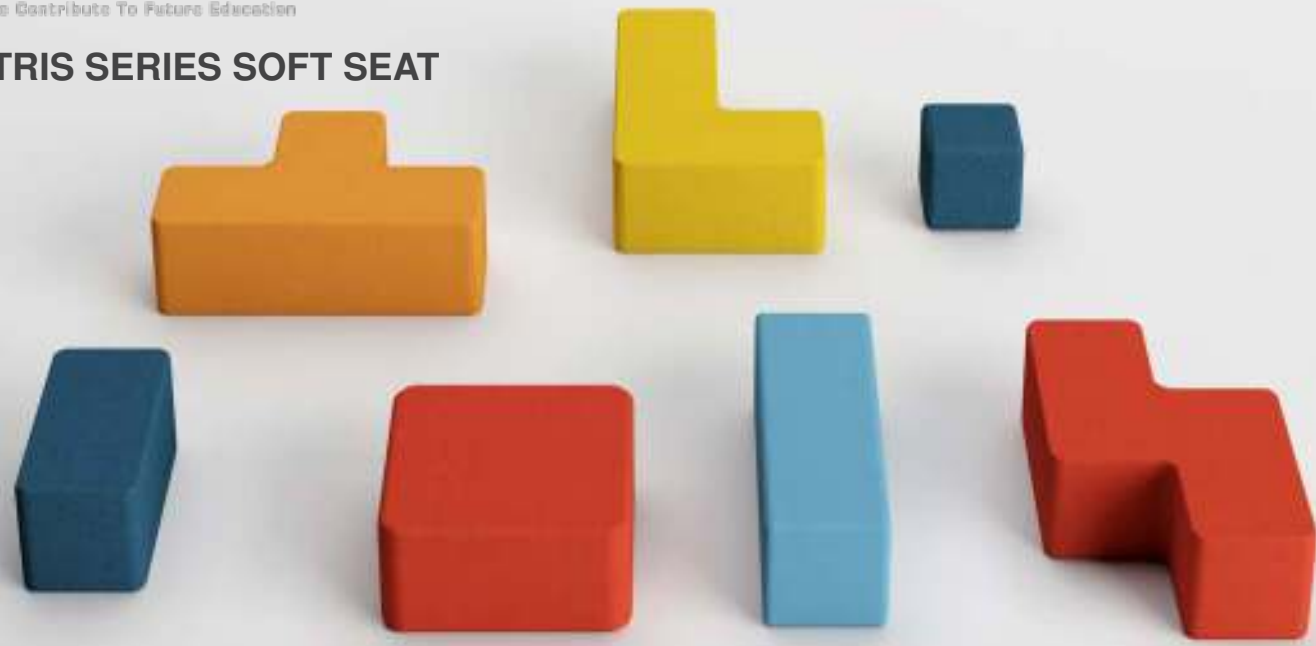

- Upholstered in a durable PVC or Fabric finish with high density foam provides seating comfort.
- Special design allows to combine to create different combinations with multiple items

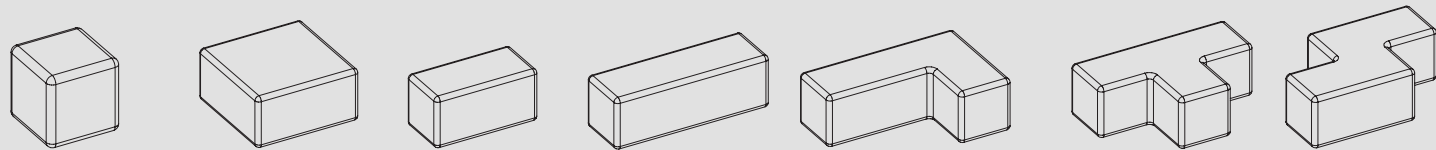

E033K1	E033L1	E033M1	E033N1	E033O1	E033P1	E033Q1
Size:	Size:	Size:	Size:	Size:	Size:	Size:
350x350x350mm	760x760x350mm	760x380x350mm	1140x380x350mm	1140x760x350mm	1140x760x350mm	1140x760x350mm
E033K2	E033L2	E033M2	E033N2	E033O2	E033P2	E033Q2
Size:	Size:	Size:	Size:	Size:	Size:	Size:
350x350x460mm	760x760x460mm	760x380x460mm	1140x380x460mm	1140x760x460mm	1140x760x460mm	1140x760x460mm

### BEAN BAG



E033I1

- High-quality, very sturdy 1680D polyester outdoor cover
- Inner bag with safety zip
- The cover is easy to remove and washable at 30°C
- The filling is strong styrene-reduced EPS micro-beads for a healthy atmosphere, guaranteed to keep its shape for longer
- Loads of up to 110 kg

Size:  
E033I1 - 930mm dia x 1200 mm height

### FLOOR CUSHION



E033I2

- High-quality, very sturdy 1680D polyester outdoor cover
- Inner bag with safety zip
- The cover is easy to remove and washable at 30°C
- The filling is strong styrene-reduced EPS micro-beads for a healthy atmosphere, guaranteed to keep its shape for longer
- Loads of up to 110 kg

Size:  
E012I2 - 700x700x150 mm



## CUSHION

E033I3

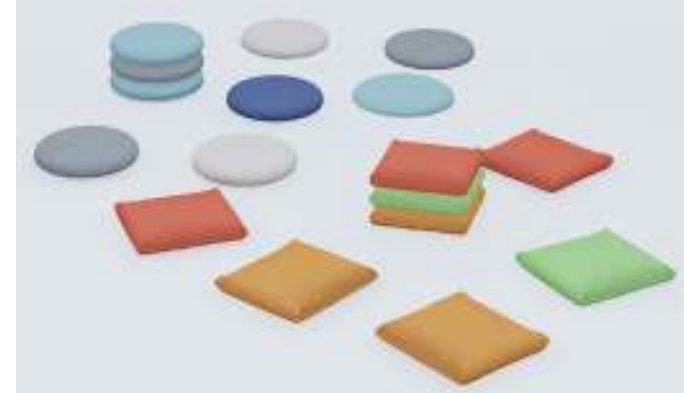

- Upholstered in a durable PVC or Fabric finish with high density foam provides seating comfort.
- Can be match with stages,benches,library units.

Size:  
E033I3- 450 mm dia x 150 mm height  
E033I3- 450x450x150 mm

## SOFA

E033J



- Upholstered in a sturdy construction and durable PVC or Fabric finish with high density foam provides seating comfort.
- a wide selection of colours and materials can be chosen as required

Size:  
E033J1 - 800x790x820 mm  
E033J2 - 1440x790x820 mm  
E033J3 - 2120x790x820 mm



# CABINETS

Tall Cabinets . . . . .	124 Me-
dium Cabinets . . . . .	126
Small Cabinets . . . . .	128
Wall Mounted Cabinets . . . . .	129
Arc Cabinets . . . . .	130
Bookshelves . . . . .	132
Island Storage . . . . .	137
Book Trolleys . . . . .	140
Forest Series . . . . .	146
Garden Series . . . . .	150
Colour Series. . . . .	153
Pixel Series . . . . .	156
Tetris Series . . . . .	160
Animal Shelves . . . . .	162
Imaginarium Series. . . . .	164



## TALL CABINETS

E041A



- Tall cabinets are good storage place for educational aids or documents. All things that you want to keep safe yet handy should go into cabinets and drawers.
- Multiple door and drawer option you can chose the best for your needs.
- Glass or laminated door options.
- With height adjustable shelves you can make the most of the cabinet space.
- Locks available for the doors and drawers.
- Available in 18mm thick Laminated Plywood or MDF or 1mm thick Mild Steel Sheet with epoxy powder coating
- Base support from epoxy powder coated mild steel tube with floor leveling jack

Size options :

- 1 - 600x400x2100mm
- 2 - 900x400x2100mm
- 3 - 1000x400x2100mm
- 4 - 1200x400x2100mm



E041B



E041C



E041D



E041E



E041F



E041G



E041H



E041I





- Medium cabinets are good storage place for educational aids or documents. All things that you want to keep safe yet handy should go into cabinets and drawers.
- Available in units with deep or shallow trays, drawers and with or without door options.
- With height adjustable shelves you can make the most of the cabinet space.
- Locks available for the doors and drawers.
- Available in 18mm thick laminated plywood or MDF or 1mm thick mild steel sheet with epoxy powder coating
- Available with base support from epoxy powder coated mild steel tube with floor levelling jack or movable with castors

Size options :

- 1 - 900x450x900mm
- 2 - 1200x450x900mm



E042A



E042B



E042C



E042D



E042E



E042F



E042G



E042H



## SMALL CABINETS

- Small cabinets are good storage place for educational aids or documents.
- Available in units with drawers and with or without door options.
- With height adjustable shelves you can make the most of the cabinet space.
- Locks available for the doors and drawers.
- Available in 18mm thick laminated plywood or MDF or 1mm thick mld steel sheet with epoxy powder coating
- Available with base support from epoxy powder coated mild steel tube with floor levelling jack or movable with castors

Size options :

- 1 - 450x450x900mm
- 2 - 500x450x900mm
- 3 - 600x450x900mm



## WALL MOUNTED CABINETS

- Multiple door option you can chose the best for your needs.
- Locks available for the doors.
- Available in 18mm thick laminated plywood or MDF or 1mm thick mld steel sheet with epoxy powder coating

E044A



Size:

- E044A1-450x300x600mm
- E044A2-600x300x600mm

E044B



Size:

- E044B1-900x300x600mm
- E044B2-1200x300x600mm

E044C



Size:

- E044C1-900x300x600mm
- E044C2-1200x300x600mm

E044D



Size:

- E044D1-450x300x600mm
- E044D2-600x300x600mm

E044E



Size:

- E044E1-900x300x600mm
- E044E2-1200x300x600mm

E044F



Size:

- E044F1-450x300x600mm
- E044F2-600x300x600mm

E044G



Size:

- E044G1-900x300x600mm
- E044G2-1200x300x600mm



## ARC CABINETS



- With these open-frame bookcases accessible from each side you will maximize the available floor space. Units easily can be combine with other modular cabinets or units to create modern and creative environment.
- Available in 18mm thick laminated plywood or MDF or 1mm thick mild steel sheet with epoxy powder coating
- Available with base support from epoxy powder coated mild steel tube with floor levelling jack or movable with castors



E045A



Size:  
E045A1: 1200x500x900mm

E045B



Size:  
E045B1: 1200x500x900mm

E045C



Size:  
E045C1: 1200x500x900mm

E045D



Size:  
E045D1: 1200x500x900mm

E045E



Size:  
E045E1: 1225x500x900mm

E044F



Size:  
E045F1: 1225x500x900mm

## LIBRARY ARC BOOK SHELVES

E046A



- Structure available in 18mm thick Laminated Plywood or MDF or 1mm thick Mild Steel Sheet with epoxy powder coating
- 2mm thick PVC edging for laminated

Size:  
E046A1 - 1200x500x800mm

## SINGLE SIDE DISPLAY CABINET

E046B



- Structure available in 18mm thick Laminated Plywood or MDF or 1mm thick Mild Steel Sheet with epoxy powder coating
- 2mm thick PVC edging for laminated

Size:  
E046B1 - 600x250x1200mm

## DOUBLE SIDE DISPLAY CABINET

E046C



- Structure available in 18mm thick Laminated Plywood or MDF or 1mm thick Mild Steel Sheet with epoxy powder coating
- 2mm thick PVC edging for laminated

Size:  
E046C1- 600x480x1200mm

## LIBRARY BOOK SHELVES-1

E046D



- Structure available in 18mm thick Laminated Plywood or MDF or 1mm thick Mild Steel Sheet with epoxy powder coating
- 2mm thick PVC edging for laminated

Size:  
E046D1 Size: 900x400x1800mm  
E046D2 Size: 1000x400x1800mm  
E046D3 Size: 1200x400x1800mm



## LIBRARY BOOK SHELVES-2

E046E



- Structure available in 18mm thick Laminated Plywood or MDF or 1mm thick Mild Steel Sheet with epoxy powder coating
- 2mm thick PVC edging for laminated

Size:

E046E1 Size: 900x600x1800mm (LxDxH)  
E046E2 Size: 1000x600x1800mm (LxDxH)  
E046E3 Size: 1200x600x1800mm (LxDxH)

## LIBRARY BOOK SHELVES-3

E046F



- Structure available in 18mm thick Laminated Plywood or MDF or 1mm thick Mild Steel Sheet with epoxy powder coating
- 2mm thick PVC edging for laminated

Size:

E046F1 Size: 900x400x1200mm (LxDxH)  
E046F2 Size: 1000x400x1200mm (LxDxH)  
E046F3 Size: 1200x400x1200mm (LxDxH)

## LIBRARY BOOK SHELVES-4

E046G



- Structure available in 18mm thick Laminated Plywood or MDF or 1mm thick Mild Steel Sheet with epoxy powder coating
- 2mm thick PVC edging for laminated

Size:

E046G1 Size: 900x600x1200mm (LxDxH)  
E046G2 Size: 1000x600x1200mm (LxDxH)  
E046G3 Size: 1200x600x1200mm (LxDxH)

## LIBRARY BOOK SHELVES-5

E046H



- Structure available in 18mm thick Laminated Plywood or MDF or 1mm thick Mild Steel Sheet with epoxy powder coating
- 2mm thick PVC edging for laminated

Size:

E046H1 Size: 900x400x1800mm (LxDxH)  
E046H2 Size: 1000x400x1800mm (LxDxH)  
E046H3 Size: 1200x400x1800mm (LxDxH)





## LIBRARY BOOK SHELVES-6

E0461



- Structure available in 18mm thick Laminated Plywood or MDF or 1mm thick Mild Steel Sheet with epoxy powder coating
- 2mm thick PVC edging for laminated

Size:

E04611 Size: 900x400x1200mm (LxDxH)

E04612 Size: 1000x400x1200mm (LxDxH)

E04613 Size: 1200x400x1200mm (LxDxH)

## ISLAND STORAGE

E047A



- Structure available in 18mm thick Laminated Plywood or MDF or 1mm thick Mild Steel Sheet with epoxy powder coating
- 2mm thick PVC edging for laminated
- Heavy duty swivel castor with 2 breaks diagonally
- Shallow Tray & Deep Tray with Plastic Runner (Available in wide range of color for client choice)

Size:

E047A1 - 900x900x500/580mm



## GAME STORAGE

E047B



- Structure available in 18mm thick Laminated Plywood or MDF or 1mm thick Mild Steel Sheet with epoxy powder coating
- 2mm thick PVC edging for laminated
- Heavy duty swivel castor with 2 breaks diagonally

Size:

E047B1 - 800x800x400mm

## ULTRA CABINET

E047C



- Structure available in 18mm thick Laminated Plywood or MDF or 1mm thick Mild Steel Sheet with epoxy powder coating
- 2mm thick PVC edging for laminated
- Heavy duty swivel castor with 2 breaks diagonally
- Shallow Tray & Deep Tray with Plastic Runner (Available in wide range of color for client choice)
- Can be matched together with modular tables

Size:

E047C1 Size: 900x360x1100mm

E047C2 Size: 1000x360x1100mm

E047C3 Size: 1200x360x1100mm

## BOOK BROWSER

E047D



- Structure available in 18mm thick Laminated Plywood or MDF or 1mm thick Mild Steel Sheet with epoxy powder coating
- 2mm thick PVC edging for laminated

Size:

E047D1 - 900x400x700mm

## BOOK CAROUSEL

E047F



- Structure available in 18mm thick Laminated Plywood or MDF or 1mm thick Mild Steel Sheet with epoxy powder coating
- Clear acrylic sheet book stop compartment
- 2mm thick PVC edging for laminated
- Heavy duty swivel castor with 2 breaks diagonally

Size:

E047F1 - 600x600x1000mm

## BOOK TOWER

E047G



- Structure available in 18mm thick Laminated Plywood or MDF or 1mm thick Mild Steel Sheet with epoxy powder coating
- Clear acrylic sheet book stop compartment
- 2mm thick PVC edging for laminated
- Heavy duty swivel castor with 2 breaks diagonally

Size:  
E047G1 - 600x600x1000mm

## BOOK DISPLAY

E047H



- Structure available in 18mm thick Laminated Plywood or MDF or 1mm thick Mild Steel Sheet with epoxy powder coating
- 2mm thick PVC edging for laminated
- Heavy duty swivel castor with 2 breaks diagonally

Size:  
E047H1 - 600x600x1750mm





### MOBILE BOOK TROLLEY-1

E048B



- Structure available in 18mm thick Laminated Plywood or MDF or 1mm thick Mild Steel Sheet with epoxy powder coating
- 2mm thick PVC edging for laminated
- Side panels 1.2mm thick Mild Steel Sheet with epoxy powder coating
- Mild Steel Pipe with epoxy powder coating frame
- Heavy duty swivel castor with 2 breaks diagonally

Size:  
E048B1 - 900x400x1100mm

### COMBINATION TROLLEY

E048C



- Structure available in 18mm thick Laminated Plywood or MDF or 1mm thick Mild Steel Sheet with epoxy powder coating
- 2mm thick PVC edging for laminated
- Side panels 1.2mm thick Mild Steel Sheet with epoxy powder coating
- Trolley completely made of mild steel with epoxy powder coating
- Heavy duty swivel castor with 2 breaks diagonally

Size:  
E048C1 - 600x500x1350mm

### MOBILE BOOK TROLLEY-1

E048D



- Upholstered in a sturdy construction and durable PVC or Fabric finish with high density foam provides seating comfort.
- a wide selection of colours and materials can be chosen as required

Size:  
E048D1 - 900x400x1100mm



## FOREST SERIES



- Series inspired from forest combines functionality with aesthetic appeal. Its diverse modules have been specifically designed to meet the demands of the young, their daily rhythm and habits. The series consist of open and close cabinets, storage cabinets, soft seats and castors.

- A unique elements is a playhouse with a soft moulded floor. The series also includes a minder's desk, which harmonize with whole series.

- All series with animal motifs engraved on the cabinets door.

- Structure available in 18mm thick Laminated Plywood or MDF

- 2mm thick PVC or paint edging

E061A



Size:  
E061A1: 1200x500x760mm

E061B



Size:  
E061B1: 1410x600x2000mm

E061C



Size:  
E061C1: 400x400x230mm - 4 pcs

E061D



Size:  
E061D1: 1000x400x760mm

E061E



Size:  
E061E1: 500x400x800mm - 2 pcs



E061F



Size:  
E061F1: 1000x400x1400mm

E061G



Size:  
E061G1: 500x400x1400mm

E061H



Size:  
E061H1: 1000x400x750mm

E061I



Size:  
E061I1: 500x400x750mm

E061J



Size:  
E061J1: 900x600x1200mm

E061K



Size:  
E061K1: 800x400x850mm







## GARDEN SERIES



- Series inspired from farm and green gardens combines functionality with aesthetic appeal. Its diverse modules have been specifically designed to meet the demands of the young, their daily rhythm and habits. The series consist of open and close cabinets, storage cabinets.
- All series design with special shape back panels with motifs engraved on the cabinets door.
- Structure available in 18mm thick Laminated Plywood or MDF
- 2mm thick PVC or paint edging

E062A



Size:  
E062A1: 800x400x850mm

E062B



Size:  
E062B1: 800x400x850mm



E062C



Size:  
E062C1: 800x400x850mm

E062D



Size:  
E062D1: 800x400x850mm

E062E



Size:  
E062E1: 800x400x850mm

E062F



Size:  
E062F1: 800x400x1650mm

E062G



Size:  
E062G1: 400x400x1250mm

E062H



Size:  
E062H1: 400x400x1650mm

## COLOUR SERIES



- Series inspires from colourful imagination of kids. Its diverse modules have been specifically designed to meet the demands of the young, their daily rhythm and habits. The series consist of open and close cabinets, storage cabinets.
- Structure available in 18mm thick Laminated Plywood or MDF
- 2mm thick PVC or paint edging

E064A



Size:  
E064A1: 800x400x900mm

E064B



Size:  
E064B1: 800x400x900mm

E064C



Size:  
E064C1: 800x400x900mm

E064D



Size:  
E064D1: 800x400x1095mm

E064E



Size:  
E064E1: 800x400x1095mm

E064F



Size:  
E064F1: 800x400x2000mm





## PIXEL SERIES



- Series inspires from colourful imagination of kids. Its diverse modules have been specifically designed to meet the demands of the young, their daily rhythm and habits. The series consist of open and close cabinets, storage cabinets.
- Structure available in 18mm thick Laminated Plywood or MDF
- 2mm thick PVC or paint edging

E063A



Size:  
E063A1: 1000x350x1080mm

E063B



Size:  
E063B1: 675x350x1080mm

E063C



Size:  
E063C1: 1000x350x755mm

E063D



Size:  
E063D1: 1000x350x1080mm

E063E



Size:  
E063E1: 1000x350x1080mm

E063F



Size:  
E063F1: 675x350x1080mm

E063G



Size:  
E063G1: 1000x350x1080mm

E063H



Size:  
E063H1: 1000x350x1080mm

E063I



Size:  
E063I1: 1000x350x1080mm

E063J



Size:  
E063J1: 850x350x1900mm







- Series inspires by famous game “TETRIS”. Its diverse modules have been specifically designed to meet the demands of the young, their daily rhythm and habits. The series consist of open and close storage cabinets and shelves.
- Structure available in 18mm thick Laminated Plywood or MDF
- 2mm thick PVC or paint edging

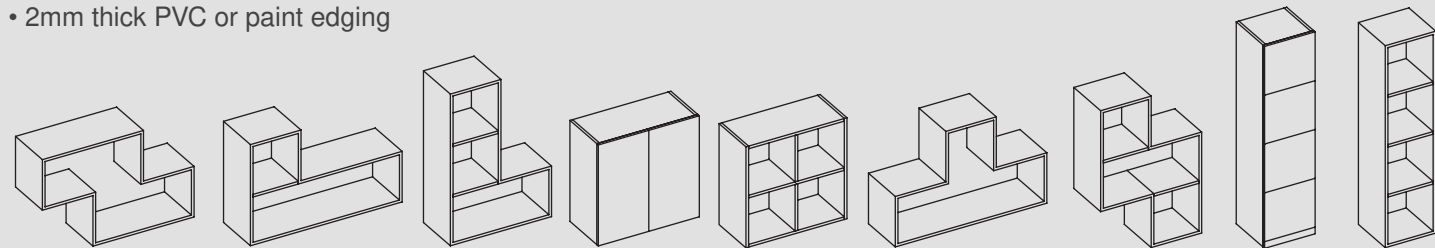

E069A1	E069B1 - E069C1	E069D1 - E069E1	E069F1	E069G1	E069H1 - E069I1
Size: 1140x350x760mm	Size: 1140x350x760mm	Size: 760x370x760mm	Size: 1140x350x760mm	Size: 760x350x1140mm	Size: 380x370x1520mm

## TETRIS ISLAND SERIES



- Series inspires by famous game of old time “TETRIS”. Its diverse modules have been specifically designed to meet the demands of the young, their daily rhythm and habits. The series consist of island storage cabinets.
- Structure available in 18mm thick Laminated Plywood or MDF
- 2mm thick PVC or paint edging

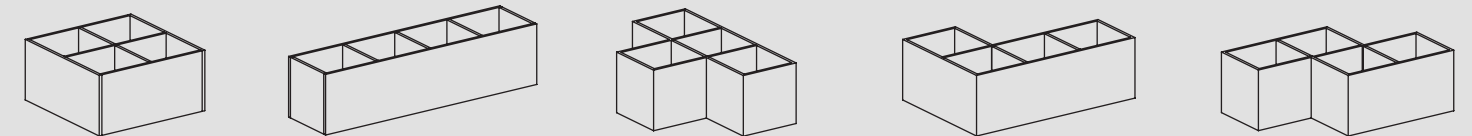

E069J1	E069K1	E069L1	E069M1	E069N1
Size: 800x800x400mm	Size: 1600x400x400mm	Size: 1200x800x400mm	Size: 1200x800x400mm	Size: 1200x800x400mm

**ANIMAL SERIES**



- Animal shaped wall shelves designed to bring colourful animals to kids play zones.
- Panels & shelves from 18mm thick Laminated MDF or 13mm thick Solid Core HPL
- Back panel 6mm thick one side laminated faced MDF or 6mm thick Solid Core HPL
- 2mm thick PVC edging for laminated





## TREE SHELVES



E065A



E065B



E065C

- Structure available in 18mm thick Laminated MR MDF or 13mm thick Solid Core HPL
- 2mm thick PVC OR painted edging

Size:

E065A1 - 1200x600x1200mm

E065A1 - 1200x600x1200mm

E065A1 - 1200x600x1200mm

## ELEPHANT SHELVES ISLAND



E067A - E067B

- Panels & shelves from 18mm thick Laminated MDF or 13mm thick Solid Core HPL
- Back panel 6mm thick one side laminated faced MDF or 6mm thick Solid Core HPL
- 2mm thick PVC edging for laminated

Size:

E067A1 - 1220x600x1065mm

E067B1 - 1525x800x1330mm

## CAMEL SHELVES ISLAND



E067C

- Panels & shelves from 18mm thick Laminated MDF or 13mm thick Solid Core HPL
- Back panel 6mm thick one side laminated faced MDF or 6mm thick Solid Core HPL
- 2mm thick PVC edging for laminated

Size:

E067C1 - 775x1000x900mm

## HOUSE SHELF SMALL

E067D



- Panels & shelves from 18mm thick Laminated MDF or 13mm thick Solid Core HPL
- Back panel 6mm thick one side laminated faced MDF or 6mm thick Solid Core HPL
- 2mm thick PVC edging for laminated
- Heavy duty swivel castor with 2 breaks diagonally

Size:  
E067D1 - 600x600x1300mm

## HOUSE SHELF BIG

E067E



- Panels & shelves from 18mm thick Laminated MDF or 13mm thick Solid Core HPL
- Back panel 6mm thick one side laminated faced MDF or 6mm thick Solid Core HPL
- 2mm thick PVC edging for laminated
- Heavy duty swivel castor with 2 breaks diagonally

Size:  
E067E1 - 1200x600x1400mm

## BOOK SHIP

E068A



- Panels & shelves from 18mm thick Laminated MDF or 13mm thick Solid Core HPL
- Back panel 6mm thick one side laminated faced MDF or 6mm thick Solid Core HPL
- 2mm thick PVC edging for laminated

Size:  
E068A1 - 1200x600x1500mm

## READING SHIP

E068B



- Panels & shelves from 18mm thick Laminated MDF or 13mm thick Solid Core HPL
- Back panel 6mm thick one side laminated faced MDF or 6mm thick Solid Core HPL
- 2mm thick PVC edging for laminated

Size:  
E068B1 - 1600x600x1500mm



**BOOK BOX**

E068C



- Panels & shelves from 18mm thick Laminated MDF or 13mm thick Solid Core HPL
- Back panel 6mm thick one side laminated faced MDF or 6mm thick Solid Core HPL
- 2mm thick PVC edging for laminated

Size:

- E068C1 - 600x600x300mm
- E068C2 - 600x600x500mm
- E068C3 - 600x600x700mm

**SPACE SHIP**

E068D



- Panels & shelves from 18mm thick Laminated MDF or 13mm thick Solid Core HPL
- Back panel 6mm thick one side laminated faced MDF or 6mm thick Solid Core HPL
- 2mm thick PVC edging for laminated

Size:

- E067E1 - 1800x1800x1900mm



**Copy Writing**

| Strategist | WordSmith | Grammarist

The Framework	
General Problem	Get their attention
Relate to Customer	Make it relevant / Cultural
Get Specific	Supporting data
Present Solution	Your Solution (Annually)
Introduce Yourself	Why are you the BEST

Buying Cycle

Identify the Problem → Define the Problem → Find a Solution → Pick a Vendor

Customers...  
Don't want to be sold to.  
Want to learn something.

Advanced Technique:  
Start a story, build to the climax, STOP

Epinephrine →  → Serotonin

**20 minutes**

**Copy Writing**



**Growth/Shrinkage of Search Visibility**

**Why?** Track competitors' successes  
Watch for potential penalties  
Explain why traffic is up/down

**How?** **SEMRush** → rankings  
**SimilarWeb** → Competitive traffic  
**Analytics** → Your traffic



**Traffic Data**

**Why?** Competitive comparison  
ID missed opportunities

**How?**  SimilarWeb  
Jumpshot  
Quantcast (qualified only)  
Alexa? Comscore? Compete?

**Copy Writing**

Strategist | WordSmith | Grammarist

**Copy Writing**



## MOBILE WHITE BOARD

E111A



- Magnetic porcelain finish board sheet white
- With 9mm thick MDF internal panel
- With aluminium profile side rail and with pen tray
- Metal frame from 50x25x2mm thick Mild steel tube with epoxy powder coating
- With 50mm dia swivel castor 2 nos. with break diagonally

Size:

E111A1 - 1500mm x 1000mm

## WHITE BOARD

E111B



- Magnetic porcelene finish board sheet white
- Back from 9mm thick MDF with aluminium foil tape
- With aluminium profile side rail
- with pen tray

Size:

E111B1 - 2400x1200mm

E111B2 - 1800x1200mm

E111B3 - 1200x1200mm

## BOOK SHIP

E111C



- 6mm thick cork board with fabric for notice board
- Back from MDF with aluminium foil tape
- With aluminium profile side rail

Size:

E111B1 - 2400x1200mm

E111B2 - 1800x1200mm

E111B3 - 1200x1200mm

## MEDIA UNIT

O033A



- Media Unit with TV niche from 18mm thick Laminated MDF
- Top available in 12mm thick Solid Surface (Acrylic), 24mm thick Laminated MR MDF, 13mm thick Solid Core HPL
- Magnetic porcelain finish board sheet white
- Legs with powder coated mild steel
- Available with swivel castors

Size:

Worktop Height - 750mm

O033A1 - 1400x1600x1750 mm

O033A2 - 2000x1600x1750 mm

Worktop Height - 1100mm

O033A3 - 1400x1600x1750 mm

O033A4 - 2000x1600x1750 mm

## MOBILE BOARD

O033B



- Magnetic porcelain finish board sheet white
- With 9mm thick MDF internal panel
- Metal frame from 50x25x2mm thick Mild steel tube with epoxy powder coating
- With 50mm dia swivel castor 4 nos. with break diagonally

Size:

O033B1 - 1200x450x1850 mm  
O033B2 - 1500x450x1850 mm  
O033B3 - 2000x450x1850 mm

## MOBILE BOARD WITH SHELVES

O033C



- Magnetic porcelain finish board sheet white
- With 9mm thick MDF internal panel
- Shelves from 18mm thick Laminated MDF
- Metal frame from 50x25x2mm thick Mild steel tube with epoxy powder coating
- With 50mm dia swivel castor 4 nos. with break diagonally

Size:

O033C1 - 1200x450x1850 mm  
O033C2 - 1500x450x1850 mm  
O033C3 - 2000x450x1850 mm

## MOBILE BOARD WITH SHELVES

O033D



- Magnetic porcelain finish board sheet white
- With 9mm thick MDF internal panel
- Shelves from 18mm thick Laminated MDF
- Metal frame from 50x25x2mm thick Mild steel tube with epoxy powder coating
- With 50mm dia swivel castor 4 nos. with break diagonally

Size:

O033D1 - 1200x450x1850 mm  
O033D2 - 1500x450x1850 mm  
O033D3 - 2000x450x1850 mm

## MOBILE BOARD WITH CABINET

O033E



- Magnetic porcelain finish board sheet white
- With 9mm thick MDF internal panel
- Shelves from 18mm thick Laminated MDF
- Metal frame from 50x25x2mm thick Mild steel tube with epoxy powder coating
- With 50mm dia swivel castor 4 nos. with break diagonally

Size:

O033E1 - 1200x450x1850 mm  
O033E2 - 1500x450x1850 mm  
O033E3 - 2000x450x1850 mm



## MOBILE BOARD WITH BENCH

O033F



- Magnetic porcelain finish board sheet white
- With 9mm thick MDF internal panel
- Shelves from 18mm thick Laminated MDF
- Metal frame from 50x25x2mm thick Mild steel tube with epoxy powder coating
- Upholstered in a durable PVC or Fabric finish with high density foam provides seating comfort.
- With 50mm dia swivel castor 4 nos. with break diagonally

Size:

O033F1 - 1200x450x1850 mm  
O033F2 - 1500x450x1850 mm  
O033F3 - 2000x450x1850 mm

## MOBILE BOARD WITH BENCH

O033G



- Magnetic porcelain finish board sheet white
- With 9mm thick MDF internal panel
- Shelves from 18mm thick Laminated MDF
- Metal frame from 50x25x2mm thick Mild steel tube with epoxy powder coating
- Upholstered in a durable PVC or Fabric finish with high density foam provides seating comfort.
- With 50mm dia swivel castor 4 nos. with break diagonally

Size:

O033G1 - 1200x450x1850 mm  
O033G2 - 1500x450x1850 mm  
O033G3 - 2000x450x1850 mm

# LOCKERS

Colour Lockers . . . . . 172

Pigeon Holes . . . . . 173

Basic Lockers . . . . . 174

Rainbow Series . . . . . 178

Giraffe Series . . . . . 180

Benches & Shelves . . . . . 182





## ZIG ZAG LOCKER

E051A

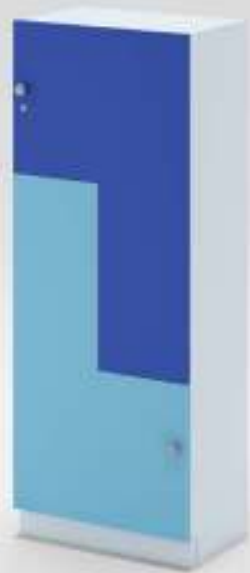

- Structure available in 18mm thick Laminated MR MDF or 13mm thick Solid Core HPL
  - Back panel 6mm thick one side laminated faced MR MDF or 6mm thick Solid Core HPL
  - 2mm thick PVC edging for laminated
  - Accessories consist of the following:  
Door Knob  
Door Lock with Master Key  
Chrome Coat Hook  
Chrome Hanger Rod  
Number Plate Holder for MR MDF Door  
Number Engrave for Solid Core HPL Door
- Size:  
E051A1 - 700x450x1800mm

## BENCH WITH COAT HOOKS

E053A



- Seating & backrest from 40x40mm thick Solid Wood with natural lacquer finish or 13mm thick Solid Core HPL
  - Top panels from 20mm thick Solid Wood with natural lacquer finish or 13mm thick Solid Core HPL
  - 2mm thick PVC edging for laminated
  - Solid wood finish:  
Natural Lacquer Finish or Paint Finish
  - Support frame epoxy powder coated mild steel tube with floor levelling jack
  - Accessories: Chrome Coat Hook
- Size:  
E053A1 - 1200x630x1700mm

## PIGEON HOLE

E054A



- Panels & shelves from 18mm thick Laminated MDF or 13mm thick Solid Core HPL
  - Back panel 6mm thick one side laminated faced MDF or 6mm thick Solid Core HPL
  - 2mm thick PVC edging for laminated
- Size:  
E054A1 - 1200x300x1500mm

## PIGEON HOLE

E054B



- Panels & shelves from 18mm thick Laminated MDF or 13mm thick Solid Core HPL
  - Back panel 6mm thick one side laminated faced MDF or 6mm thick Solid Core HPL
  - 2mm thick PVC edging for laminated
- Size:  
E054B1 - 1500x300x1500mm

## LOCKERS

- Structure available in 18mm thick Laminated MR MDF or 13mm thick Solid Core HPL or 1mm thick Mild Steel Sheet with epoxy powder coating
- Back panel 6mm thick one side laminated faced MR MDF or 6mm thick Solid Core HPL or 1mm thick Mild Steel Sheet with epoxy powder coating
- 2mm thick PVC edging for laminated
- Base support frame epoxy powder coated mild steel tube with floor levelling jack
- Accessories:  
Door Knob  
Door Lock (with Master Key)  
Chrome Coat Hook  
Chrome Hanger Rod  
Number Plate Holder for MR MDF Door & MS Door  
Number Engrave for Solid Core HPL Door

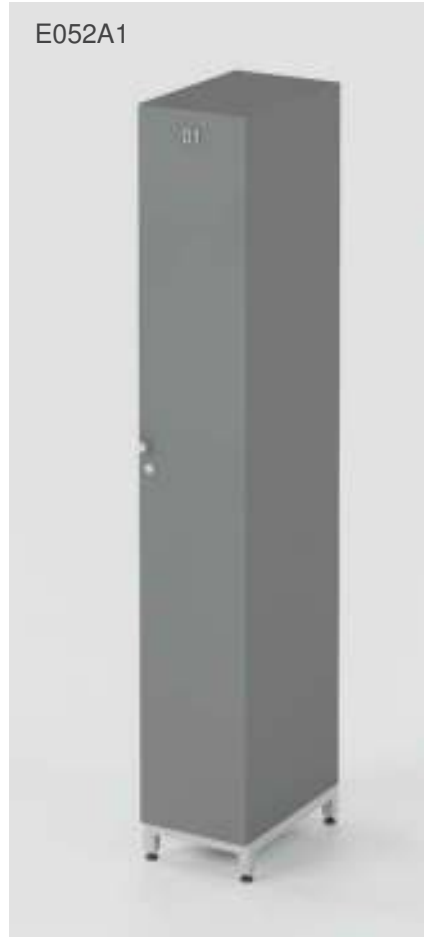

Locker One Tier

Total Size: 300x450x1900mm  
Door Size: 300x1800mm



Locker Two Tier

Total Size: 300x450x1900mm  
Door Size: 300x900mm



Locker Three Tier

Total Size: 300x450x1900mm  
Door Size: 300x600mm



Locker Four Tier

Total Size: 300x450x1900mm  
Door Size: 300x450mm



Locker SixTier

Total Size: 300x450x1900mm  
Door Size: 300x450mm



### CLOAK ROOM CABINET-1

E055A



- Panels & shelves from 18mm thick Laminated MDF or 13mm thick Solid Core HPL
- Back panel 6mm thick one side laminated faced MDF or 6mm thick Solid Core HPL
- 2mm thick PVC edging for laminated

Size:  
E055A1 - 600x600x1200mm

### CLOAK ROOM CABINET-2

E055B



- Panels & shelves from 18mm thick Laminated MDF or 13mm thick Solid Core HPL
- Back panel 6mm thick one side laminated faced MDF or 6mm thick Solid Core HPL
- 2mm thick PVC edging for laminated

Size:  
E055B1 - 1200x600x1200mm

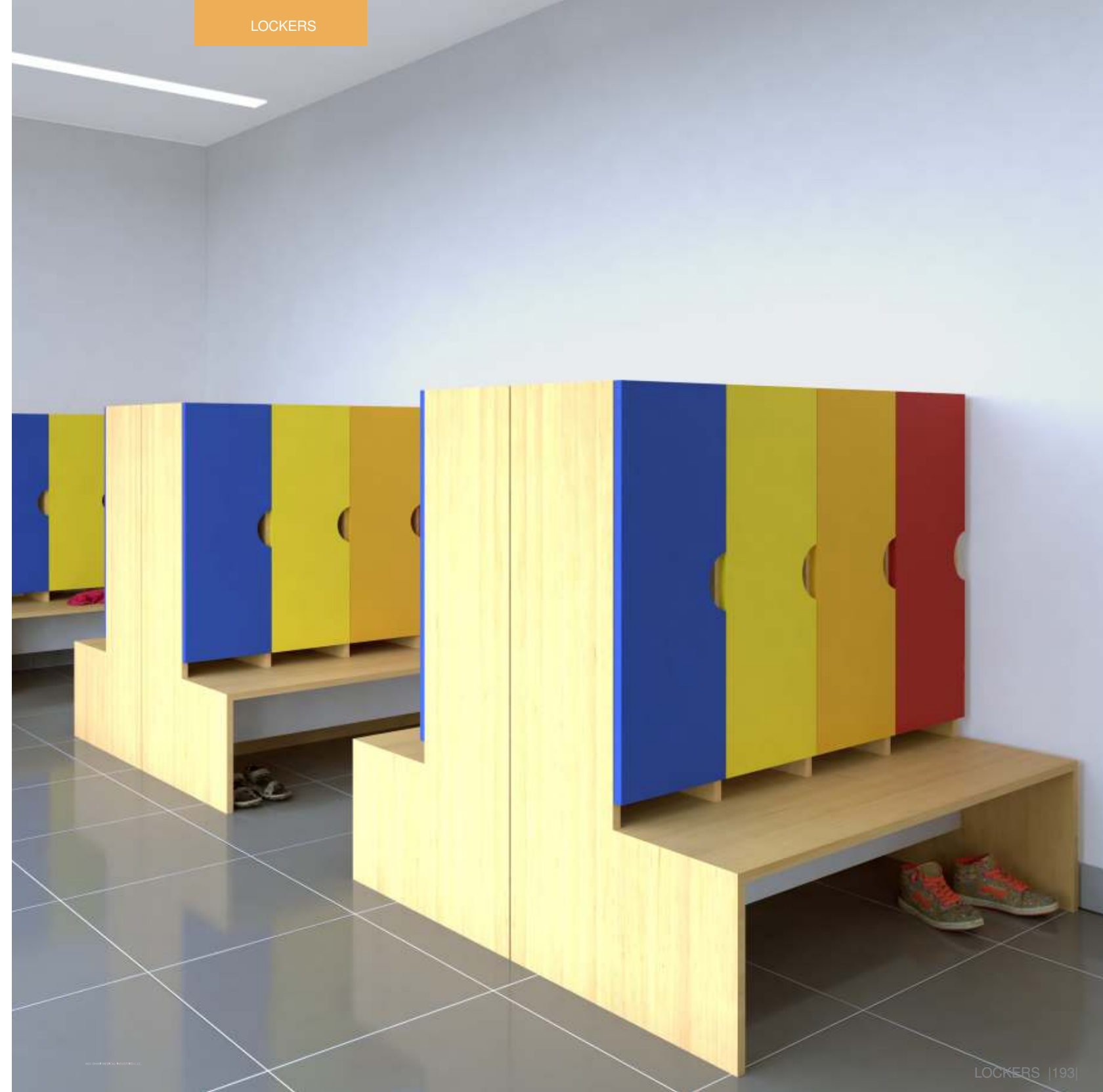

### GIRAFFE CLOAK ROOM UNIT-1

E056A



- Panels & shelves from 18mm thick Laminated MDF or 13mm thick Solid Core HPL
- Back panel 6mm thick one side laminated faced MDF or 6mm thick Solid Core HPL
- 2mm thick PVC edging for laminated
- Accessories: Chrome Coat Hook

Size:  
E056A1 - 600x600x1200mm

### GIRAFFE CLOAK ROOM UNIT-2

E056B



- Upholstered in a sturdy construction and durable PVC or Fabric finish with high density foam provides seating comfort.
- a wide selection of colours and materials can be chosen as required
- Accessories: Chrome Coat Hook

Size:  
E056B1 - 1200x600x1200mm

### COLOR CLOAK ROOM UNIT-1

E057A



- Complete panels from 18mm thick Laminated MDF or 13mm thick Solid Core HPL
- Support frame from epoxy powder coated mild steel tube with floor levelling jack
- 2mm thick PVC edging for laminated
- Bottom shelf epoxy powder coated mild steel rod

Size:  
E057A1 - 600x400x1200mm

### COLOR CLOAK ROOM UNIT-2

E057B



- Complete panels from 18mm thick Laminated MDF or 13mm thick Solid Core HPL
- Support frame from epoxy powder coated mild steel tube with floor levelling jack
- 2mm thick PVC edging for laminated
- Bottom shelf epoxy powder coated mild steel rod

Size:  
E057B1 - 700x700x150 mm



**BENCHES-1**

E058A



- Seating top & panels from 18mm thick Laminated MDF or 13mm thick Solid Core HPL
- 2mm thick PVC edging for laminated
- Bottom shelf epoxy powder coated mild steel rod

Size:  
E058A1 - 600x400x350mm

**BENCHES-2**

E058B



- Seating top & panels from 18mm thick Laminated MDF or 13mm thick Solid Core HPL
- 2mm thick PVC edging for laminated
- Bottom shelf epoxy powder coated mild steel rod

Size:  
E058B1 - 1200x400x350mm

**WALL MOUNTED SHELF-1**

E058D



- Panels & shelves from 18mm thick Laminated MDF or 13mm thick Solid Core HPL

Size:  
E058D1 - 600x300x300mm

**WALL MOUNTED SHELF-2**

E058E



- Panels & shelves from 18mm thick Laminated MDF or 13mm thick Solid Core HPL

Size:  
E058E1 - 1200x300x300mm

# INNOVATION FURNITURES

Collaboration Series . . . . .	186
Media Workstations . . . . .	194
Move Series . . . . .	196
Nest Series . . . . .	200
Pods . . . . .	202
Stages . . . . .	205
Team Benches . . . . .	208
Workshop Series . . . . .	210





## ANGLE COLLABORATION SYSTEM



Collaboration system multi-functional, multi-zone can be configured to create different types of working spaces. It's a structure that instantly creates variety of flexible space without needing bring in builders. Users can move the seating to suit what they are doing.



For meetings seating can be arranged around a table, nested into the space with their back to the wall so users face each other. For presentation and brain storms the seats can be arranged to face the surface which can be used as a whiteboard and the seating can be arranged in multiple configurations to accommodate various collaborative tasks. It can be done with various heights and because it is a modular system we can design exactly the right size and seating combination for your space. It is a great solution for creating flexible spaces without any construction needed.









## CURVE COLLABORATION SYSTEM



Collaboration system multi-functional, multizone can be configured to create different types of working spaces. It's a structure that instantly creates variety of flexible space without needing bring in builders. Users can move the seating to suit what they are doing.



For meetings seating can be arranged around a table, nested into the space with their back to the wall so users face each other. For presentation and brain storms the seats can be arranged to face the surface which can be used as a whiteboard and the seating can be arranged in multiple configurations to accommodate various collaborative tasks. It can be done with various heights and because it is a modular system we can design exactly the right size and seating combination for your space. It is a great solution for creating flexible spaces without any construction needed.





### ANGLE COLLABORATION SYTEM MODULES

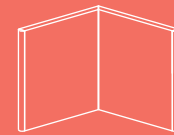

E071A



E071B



E071C



E071D



E071E



E071F



E071G



E071H



E071I



E071J

### CURVE COLLABORATION SYTEM MODULES

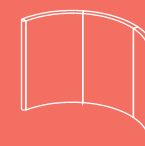

E072A



E072B



E072C



E072D



E072E



E072F



E072G



E072H



E072I



E072J



## MEDIA WORK STATION



Multi-functional wall unit with workstation, storage, desk and sliding board system. Available in many finishes, it blends in with the design scheme of any interior.

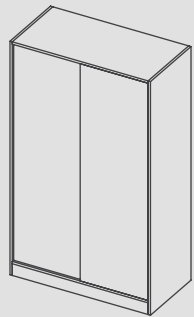

E073A1  
Size:  
1200x600x2000mm

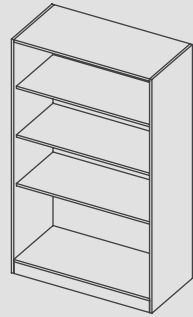

E073B1  
Size:  
1200x600x2000mm

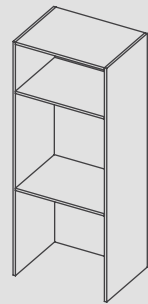

E073C1  
Size:  
800x600x2000mm

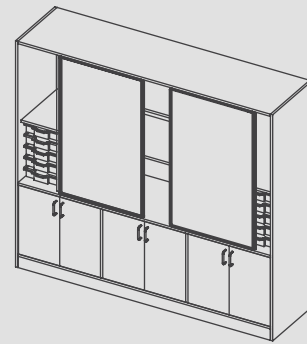

E073D1  
Size:  
2200x600x2000mm



## MOVE SERIES SEAT 1

E074A



- Movable Seating unit with storage
- From 18mm MDF or Plywood with 0.9mm thick High Pressure Decorative Laminate (HPDL) hot pressed
- 2mm thick PVC edging
- Upholstered in a durable PVC or Fabric finish with High density foam provides seating comfort.
- Heavy duty swivel castor with 2 breaks diagonally

Size:  
E074A1- 1500x700x1100mm

## MOVE SERIES SEAT 2

E074B



- Movable Seating unit with storage and desk on the back side
- From 18mm MDF or Plywood with 0.9mm thick High Pressure Decorative Laminate (HPDL) hot pressed
- 2mm thick PVC edging
- Upholstered in a durable PVC or Fabric finish with High density foam provides seating comfort.
- Heavy duty swivel castor with 2 breaks diagonally

Size:  
E074B1 - 1150x1500x1100mm

## MOVE SERIES SHELF 1

E074C



- Movable storage unit
- From 18mm MDF or Plywood with 0.9mm thick High Pressure Decorative Laminate (HPDL) hot pressed
- 2mm thick PVC edging
- Upholstered in a durable PVC or Fabric finish with High density foam provides seating comfort.
- Heavy duty swivel castor with 2 breaks diagonally

Size:  
E074C1 - 1200x600x900mm

## MOVE SERIES SHELF 2

E074D



- Movable storage unit
- From 18mm MDF or Plywood with 0.9mm thick High Pressure Decorative Laminate (HPDL) hot pressed
- 2mm thick PVC edging
- Upholstered in a durable PVC or Fabric finish with High density foam provides seating comfort.
- Heavy duty swivel castor with 2 breaks diagonally

Size:  
E074D- 1200x700x900mm



## MOVE SERIES BOARD

E074E



- Movable White board unit with storage shelves
- From 18mm MDF or Plywood with 0.9mm thick High Pressure Decorative Laminate (HPDL) hot pressed
- 2mm thick PVC edging
- Upholstered in a durable PVC or Fabric finish with High density foam provides seating comfort.
- Heavy duty swivel castor with 2 breaks diagonally

Size:  
E058A- 600x400x350mm





## NEST SERIES



Nest Series is a highly adaptable, modular system which can be easily reconfigured to suit the confines of any space. Available in many finishes, it blends in with the design scheme of any interior.

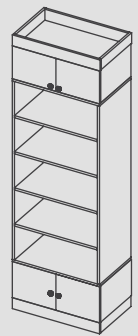

E075A1

Size:

800x500x2500mm

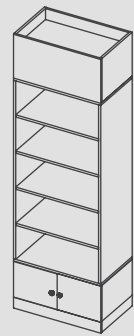

E075A2

Size:

800x500x2500mm

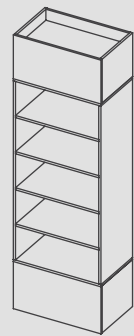

E075A3

Size:

800x500x2500mm

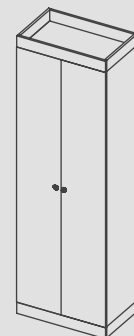

E075B1

Size:

800x500x2500mm

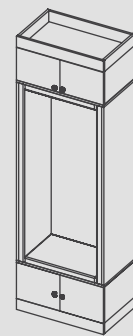

E075C1

Size:

800x500x2500mm

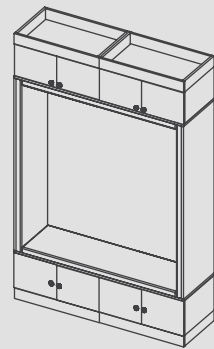

E075C2

Size:

800x500x2500mm

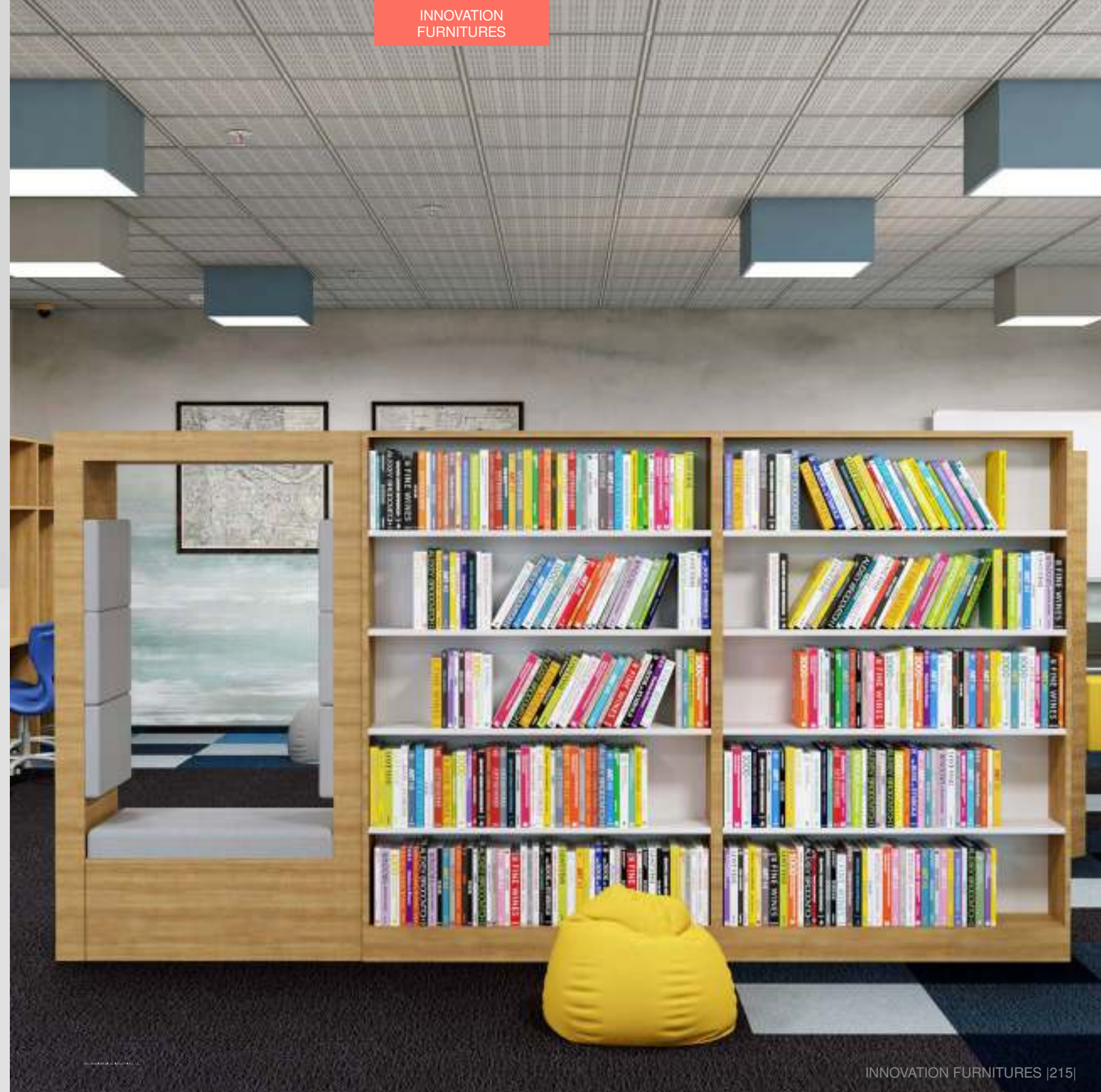



**POD 1**



E076A

- From 18mm MDF or Plywood with 0.9mm thick High Pressure Decorative Laminate (HPDL) hot pressed
- 2mm thick PVC edging
- Upholstered in a durable PVC or Fabric finish with High density foam provides seating comfort.

Size:

E076A1- 1050x700x1800mm  
E076A2- 1050x700x2100mm

**POD 2**



E076B

- From 18mm MDF or Plywood with 0.9mm thick High Pressure Decorative Laminate (HPDL) hot pressed
- 2mm thick PVC edging
- Upholstered in a durable PVC or Fabric finish with High density foam provides seating comfort.

Size:

E076B1- 1800x700x1800mm  
E076B2- 1800x700x2100mm

**POD 3**



E076C

- From 18mm MDF or Plywood with 0.9mm thick High Pressure Decorative Laminate (HPDL) hot pressed
- 2mm thick PVC edging
- Upholstered in a durable PVC or Fabric finish with High density foam provides seating comfort.

Size:

E076C1- 1800x1400x1800mm  
E076C2- 1800x1400x2100mm



### POD 4



E076D

- From 18mm MDF or Plywood with 0.9mm thick High Pressure Decorative Laminate (HPDL) hot pressed
- 2mm thick PVC edging
- Upholstered in a durable PVC or Fabric finish with High density foam provides seating comfort.

Size:

E076D1- 3500x700x1800mm

E076D2- 3500x700x2100mm

### POD 5



E076E

- From 18mm MDF or Plywood with 0.9mm thick High Pressure Decorative Laminate (HPDL) hot pressed
- 2mm thick PVC edging
- Upholstered in a durable PVC or Fabric finish with High density foam provides seating comfort.

Size:

E076E1- 3500x1400x1800mm

E076E2- 3500x1400x2100mm

### STAGE 1



E077A

- Multi purpose stage with storage spaces for books and cushions
- Cushions sold separately please check seating section for more information
- From 18mm MDF or Plywood with 0.9mm thick High Pressure Decorative Laminate (HPDL) hot pressed
- 2mm thick PVC edging
- Top with skid proof vinyl finish



E077A1

Size: 5800x1500x300mm

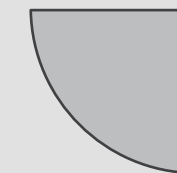

E077A2

Size: 2000x2000x300mm



E077A3

Size: 3000x1500x300mm



## STAGE 2

E077B



- Multi purpose stage with storage spaces for books and cushions
- Cushions sold separately please check seating section for more information
- From 18mm MDF or Plywood with 0.9mm thick High Pressure Decorative Laminate (HPDL) hot pressed
- 2mm thick PVC edging
- Top with skid proof vinyl finish

Size:

E077B1- 2400x2000x300mm

## STAGE 3

E076C



- Multi purpose stage with storage spaces for books and cushions
- Cushions sold separately please check seating section for more information
- From 18mm MDF or Plywood with 0.9mm thick High Pressure Decorative Laminate (HPDL) hot pressed
- 2mm thick PVC edging
- Top with skid proof vinyl finish
- Carved graphic design on front panel

Size:

E077C1- 2400x2000x600mm

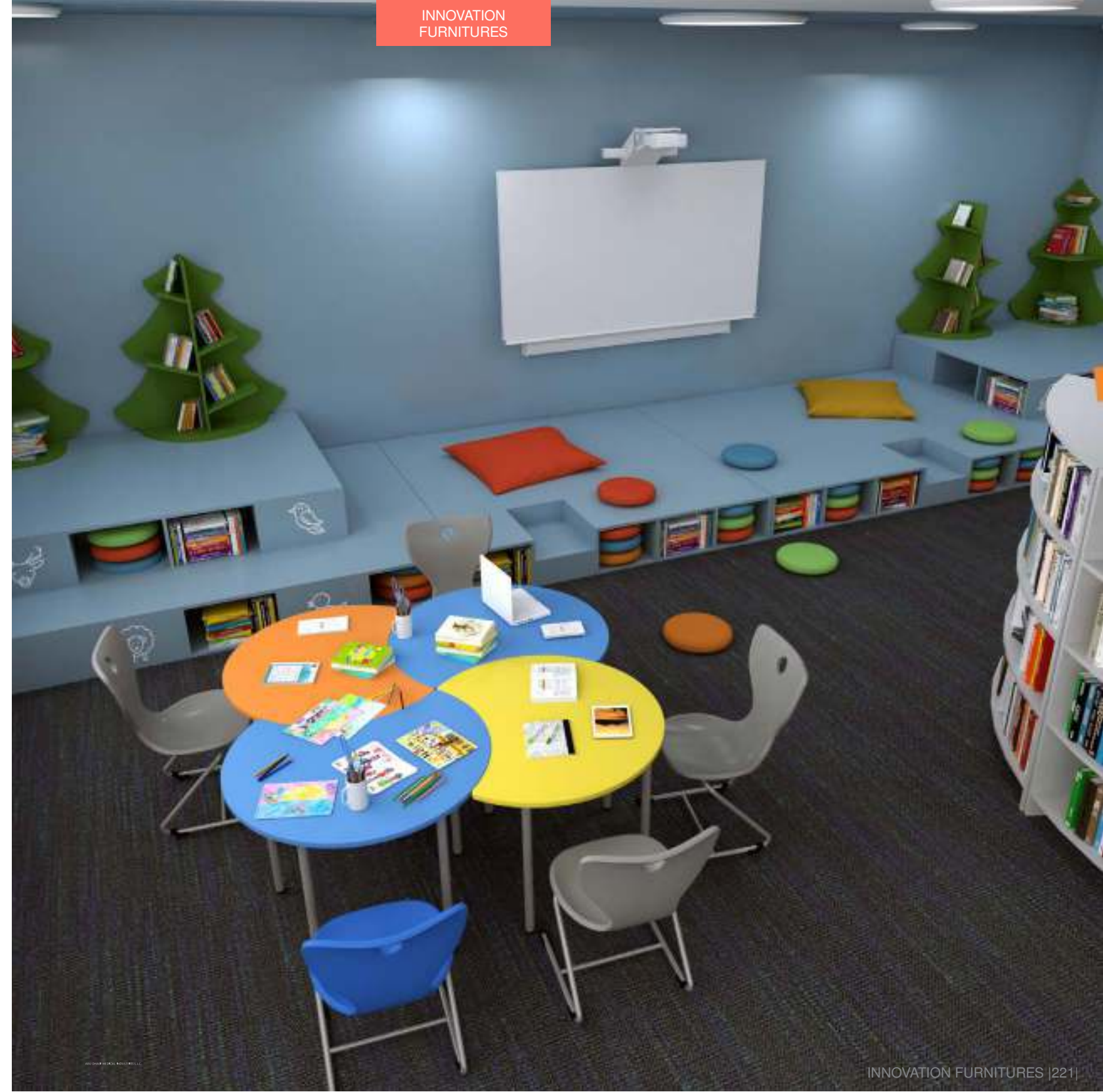



**TEAM SERIES**



Team series is perfect element to include into any place that needs a flexible seating solution. Its modular format makes it easy to fit up against a wall or into a corner. Add a storage unit either side of the bench to store your resources and if you want to use it for larger group of group simply pull out the stools that are neatly tucked away underneath. Perfect for individual or group seat.

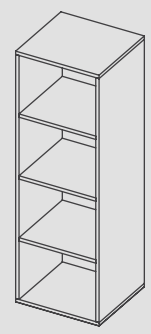

Size:  
E078A1 - 500x470x1200mm  
E078A2 - 500x470x1500mm  
E078A3 - 500x470x1800mm

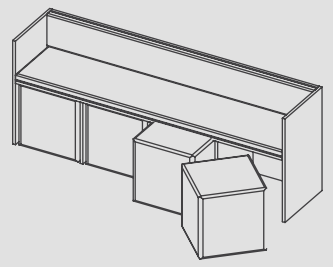

Size:  
E078B1 - 2000x470x760mm

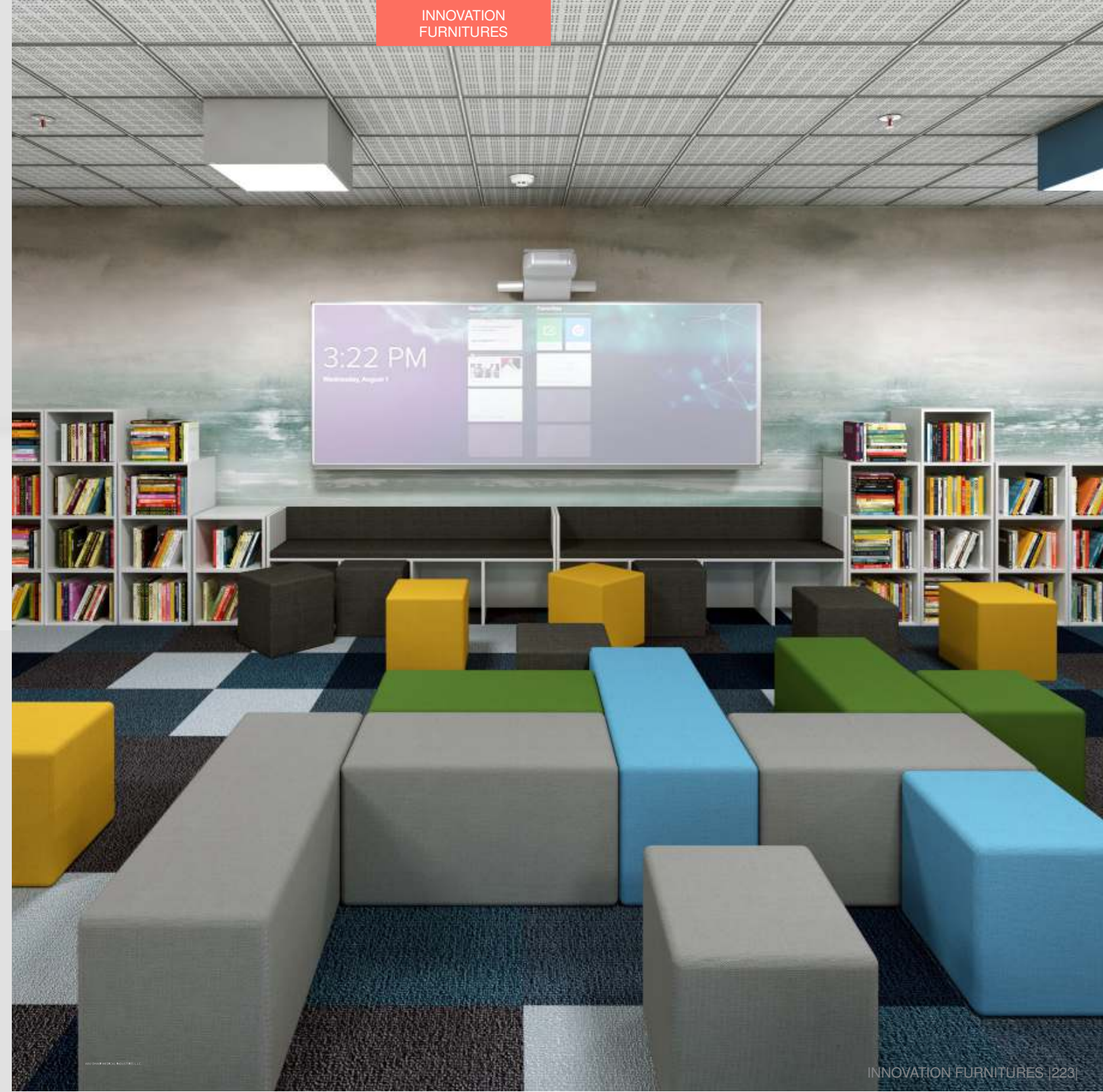



## WORKSHOP TABLE

E079A



- Tables tops selection of 16mm thick Solid phenolic resin chemical resistant / 24mm thick Laminated MDF or plywood / 30mm thick Solid Wood & Stainless steel with plywood base
- 2mm thick PVC edging
- Frame structure available in MS powder coating color as per client choice
- Optional heavy duty swivel castor with 2 breaks diagonally

Size:

E079A1- 1200x800x850mm  
E079A2- 1500x800x850mm  
E079A3- 1800x800x850mm

## WORKSHOP TABLE

E079B



- Tables tops selection of 16mm thick Solid phenolic resin chemical resistant / 24mm thick Laminated MDF or plywood / 30mm thick Solid Wood & Stainless steel with plywood base
- 2mm thick PVC edging
- Frame structure available in MS powder coating color as per client choice
- Optional heavy duty swivel castor with 2 breaks diagonally

Size:

E079B1- 1200x800x850mm  
E079B2- 1500x800x850mm  
E079B3- 1800x800x850mm

## WORKSHOP STORAGE

E079C



- Structure available in 16mm thick Solid phenolic resin chemical resistant / 24mm thick Laminated MDF or plywood / 30mm thick Solid Wood & Stainless steel with plywood base
- 2mm thick PVC edging for laminated
- Optional heavy duty swivel castor with 2 breaks diagonally

Size:

E079C1- 1440x600x850mm

## WORKSHOP STORAGE

E079D



- Structure available in 16mm thick Solid phenolic resin chemical resistant / 24mm thick Laminated MDF or plywood / 30mm thick Solid Wood & Stainless steel with plywood base
- 2mm thick PVC edging for laminated
- Optional heavy duty swivel castor with 2 breaks diagonally

Size:

E079D1- 1440x600x850mm

# MAKER SPACE





## WORKSHOP SHELF

E079E



- Shelf selection of 16mm thick Solid phenolic resin chemical resistant / 24mm thick Laminated MDF or plywood / 30mm thick Solid Wood & Stainless steel with plywood base
- 2mm thick PVC edging
- Frame structure available in MS powder coating color as per client choice
- Optional heavy duty swivel castor with 2 breaks diagonally

Size:  
E079E1- 600x600x600mm

## WORKSHOP SHELF

E079F



- Shelf selection of 16mm thick Solid phenolic resin chemical resistant / 24mm thick Laminated MDF or plywood / 30mm thick Solid Wood & Stainless steel with plywood base
- 2mm thick PVC edging
- Frame structure available in MS powder coating color as per client choice
- Optional heavy duty swivel castor with 2 breaks diagonally

Size:  
E079F1- 600x600x1200mm

## WORKSHOP SHELF

E079G



- Shelf selection of 16mm thick Solid phenolic resin chemical resistant / 24mm thick Laminated MDF or plywood / 30mm thick Solid Wood & Stainless steel with plywood base
- 2mm thick PVC edging
- Frame structure available in MS powder coating color as per client choice
- Optional heavy duty swivel castor with 2 breaks diagonally

Size:  
E079G1- 600x600x1800mm

## WORKSHOP SHELF

E079H



- Shelf selection of 16mm thick Solid phenolic resin chemical resistant / 24mm thick Laminated MDF or plywood / 30mm thick Solid Wood & Stainless steel with plywood base
- 2mm thick PVC edging
- Frame structure available in MS powder coating color as per client choice
- Optional heavy duty swivel castor with 2 breaks diagonally

Size:  
E079H1- 1200x600x600mm

## WORKSHOP SHELF

E079I



- Shelf selection of 16mm thick Solid phenolic resin chemical resistant / 24mm thick Laminated MDF or plywood / 30mm thick Solid Wood & Stainless steel with plywood base
- 2mm thick PVC edging
- Frame structure available in MS powder coating color as per client choice
- Optional heavy duty swivel castor with 2 breaks diagonally

Size:  
E079I1- 1200x600x1200mm

## WORKSHOP SHELF

E079J



- Shelf selection of 16mm thick Solid phenolic resin chemical resistant / 24mm thick Laminated MDF or plywood / 30mm thick Solid Wood & Stainless steel with plywood base
- 2mm thick PVC edging
- Frame structure available in MS powder coating color as per client choice
- Optional heavy duty swivel castor with 2 breaks diagonally

Size:  
E079J1- 1200x600x1800mm







## WORKSHOP WORK STATION

E079K



- Workshop table with services which can be selected to suit the use
  - From 18mm MDF or Plywood with 0.9mm thick High Pressure Decorative Laminate (HPDL) hot pressed
  - 2mm thick PVC edging
  - Frame structure available in MS powder coating color as per client choice
  - Non-standard materials are available for custom orders
- Size:
- E079K1- 1200x750x900mm
  - E079K2- 1500x750x900mm
  - E079K3- 1800x750x900mm
  - E079K4- 2000x750x900mm

## WORKSHOP WORK STATION

E079L



- Workshop workstation with services which can be selected to suit the use
  - From 18mm MDF or Plywood with 0.9mm thick High Pressure Decorative Laminate (HPDL) hot pressed
  - 2mm thick PVC edging
  - Frame structure available in MS powder coating color as per client choice
  - Non-standard materials are available for custom orders
- Size:
- E079L1- 1200x750x900mm
  - E079L2- 1500x750x900mm
  - E079L3- 1800x750x900mm
  - E079L4- 2000x750x900mm

## WORKSHOP WORK STATION

E079M



- Workshop workstation with services which can be selected to suit the use
- From 18mm MDF or Plywood with 0.9mm thick High Pressure Decorative Laminate (HPDL) hot pressed
- 2mm thick PVC edging
- Frame structure available in MS powder coating color as per client choice
- Non-standard materials are available for custom orders

Size:

- E079M1- 1200x750x900mm
- E079M2- 1500x750x900mm
- E079M3- 1800x750x900mm
- E079M4- 2000x750x900mm

## WORKSHOP WORK STATION

E079N



- Workshop workstation with services which can be selected to suit the use
- From 18mm MDF or Plywood with 0.9mm thick High Pressure Decorative Laminate (HPDL) hot pressed
- 2mm thick PVC edging
- Frame structure available in MS powder coating color as per client choice
- Non-standard materials are available for custom orders

Size:

- E079N1- 1200x1200x900mm

## WORKSHOP WORK STATION

E079O



- Workshop workstation with services which can be selected to suit the use
- From 18mm MDF or Plywood with 0.9mm thick High Pressure Decorative Laminate (HPDL) hot pressed
- 2mm thick PVC edging
- Frame structure available in MS powder coating color as per client choice
- Non-standard materials are available for custom orders

Size:

- E079O1- 1200x1200x900mm

## WORKSHOP WORK STATION

E079P



- From 18mm MDF or Plywood with 0.9mm thick High Pressure Decorative Laminate (HPDL) hot pressed
- 2mm thick PVC edging
- Frame structure available in MS powder coating color as per client choice
- Non-standard materials are available for custom orders

Size:

- E079P1- 1400x500x900mm





## WORKSHOP STORAGE

E079Q



- Structure available in 18mm MDF or Plywood with 0.9mm thick High Pressure Decorative Laminate (HPDL) hot pressed and Mild steel sheet epoxy powder coating
- Frame structure available in MS powder coating color as per client choice
- Heavy duty swivel castor with 2 breaks diagonally
- Non-standard materials are available for custom orders

Size:  
E079Q1- 500x500x110mm

## WORKSHOP STORAGE

E079R

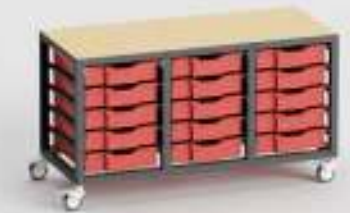

- Drawers shallow Tray with Plastic Runner
- Trays available in wide range of color for selection
- Frame structure available in MS powder coating color as per client choice
- Heavy duty swivel castor with 2 breaks diagonally

Size:  
E076R1- 1080x450x600mmmm

# AUDITORIUM FURNITURES

Conference Seats . . . . . 226  
Podiums . . . . . 229

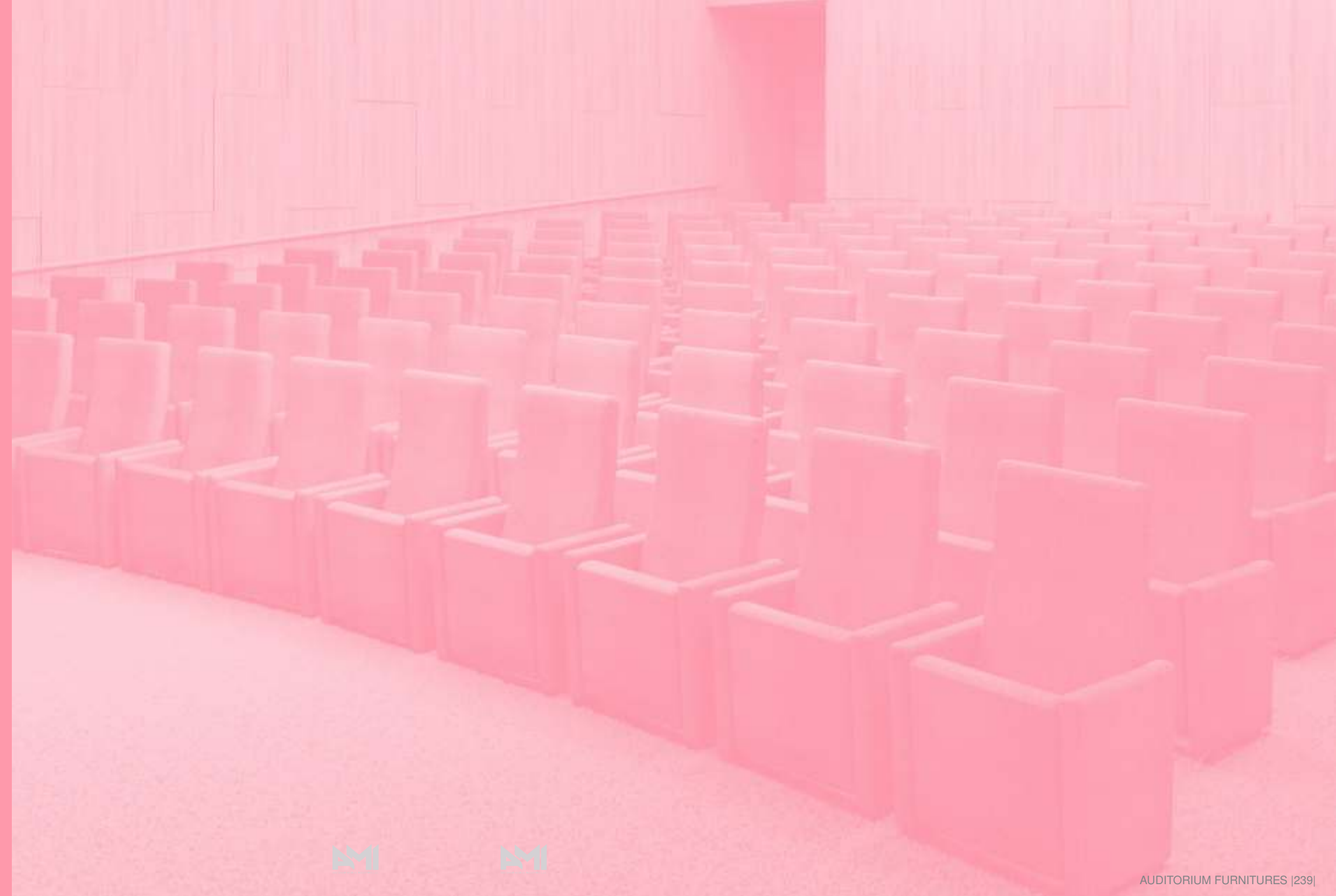



## CONFERENCE CHAIR - TULIP

E081A



- With circular and linear setup this design is an ideal system for auditoriums, conference and gyms, universities and school classes, such as show centers etc. variety of places.

*Please contact with our sales team for more information.*

## CONFERENCE CHAIR - C2

E081B



- With strong structure, aesthetic form is always the best solution for educational facilities

*Please contact with our sales team for more information.*

Size:  
E061B - 460x480x980mm

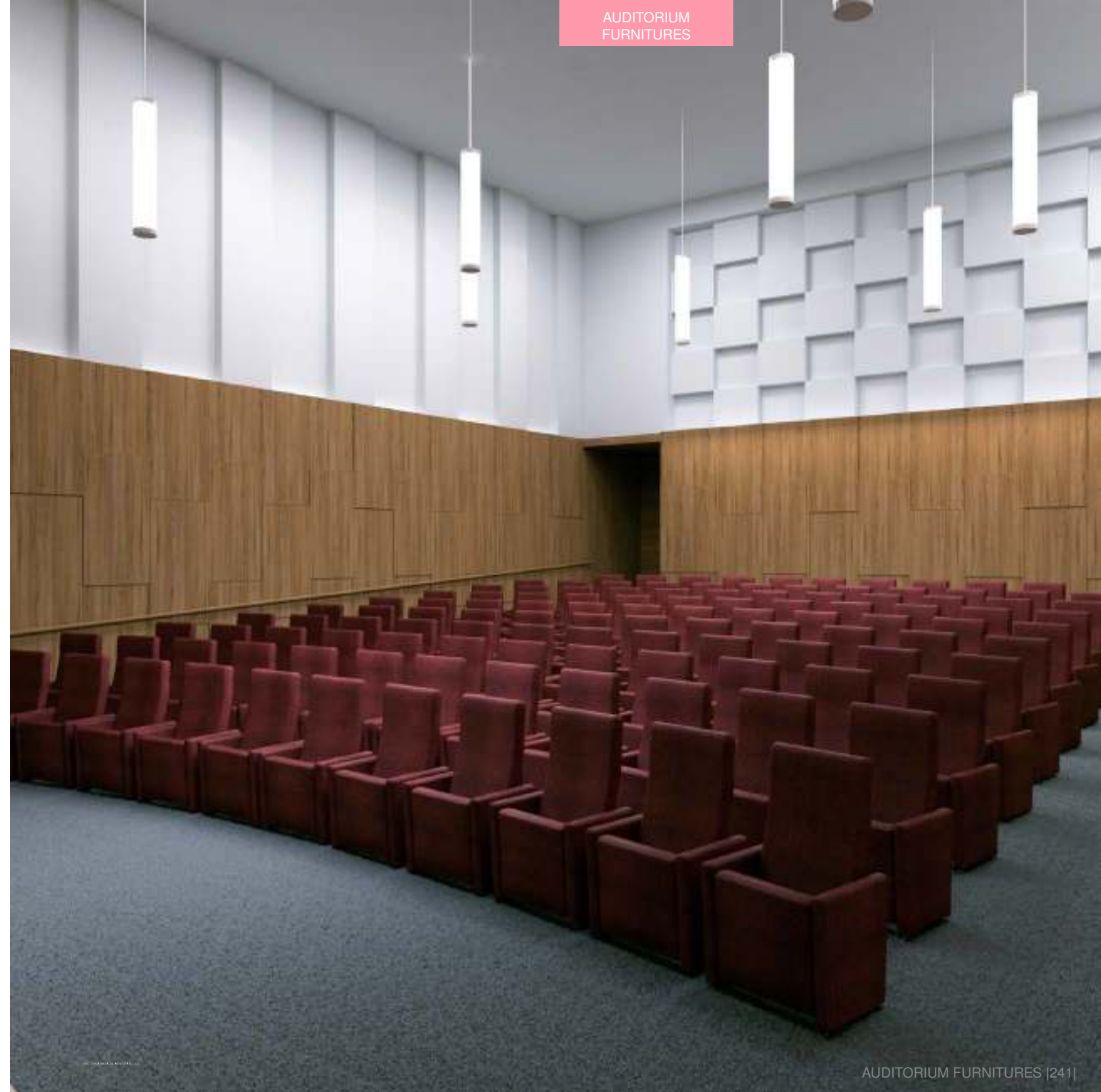

### CONFERENCE CHAIR - C3

E081C



- With strong structure, aesthetic form is always the best solution for educational facilities

*Please contact with our sales team for more information.*

Size:  
E061C- 460x480x940mm

### CONFERENCE CHAIR - C4

E081D



- With strong structure, aesthetic form is always the best solution for educational facilities

*Please contact with our sales team for more information.*

Size:  
E061D- 550x480x920mm

### PODIUM-01 GEOMETRIC

E082A



- Structure available in 18mm thick Laminated MDF or 18mm thick MDF with Veneer with natural lacquer finish
- 2mm thick PVC edging for laminated
- Electrical Outlet, Data Outlet & Cable Cover

Size:  
E082A1 Size: 600x600x1000mm  
E082A2 Size: 750x600x1000mm  
E082A3 Size: 1000x600x1000mm



**PODIUM-02 LINES**

E082B



- Structure available in 18mm thick Laminated MDF or 18mm thick MDF with Veneer with natural lacquer finish
- 2mm thick PVC edging for laminated
- Electrical Outlet, Data Outlet & Cable Cover

Size:  
E082B1 Size: 600x600x1000mm  
E082B2 Size: 750x600x1000mm  
E082B3 Size: 1000x600x1000mm

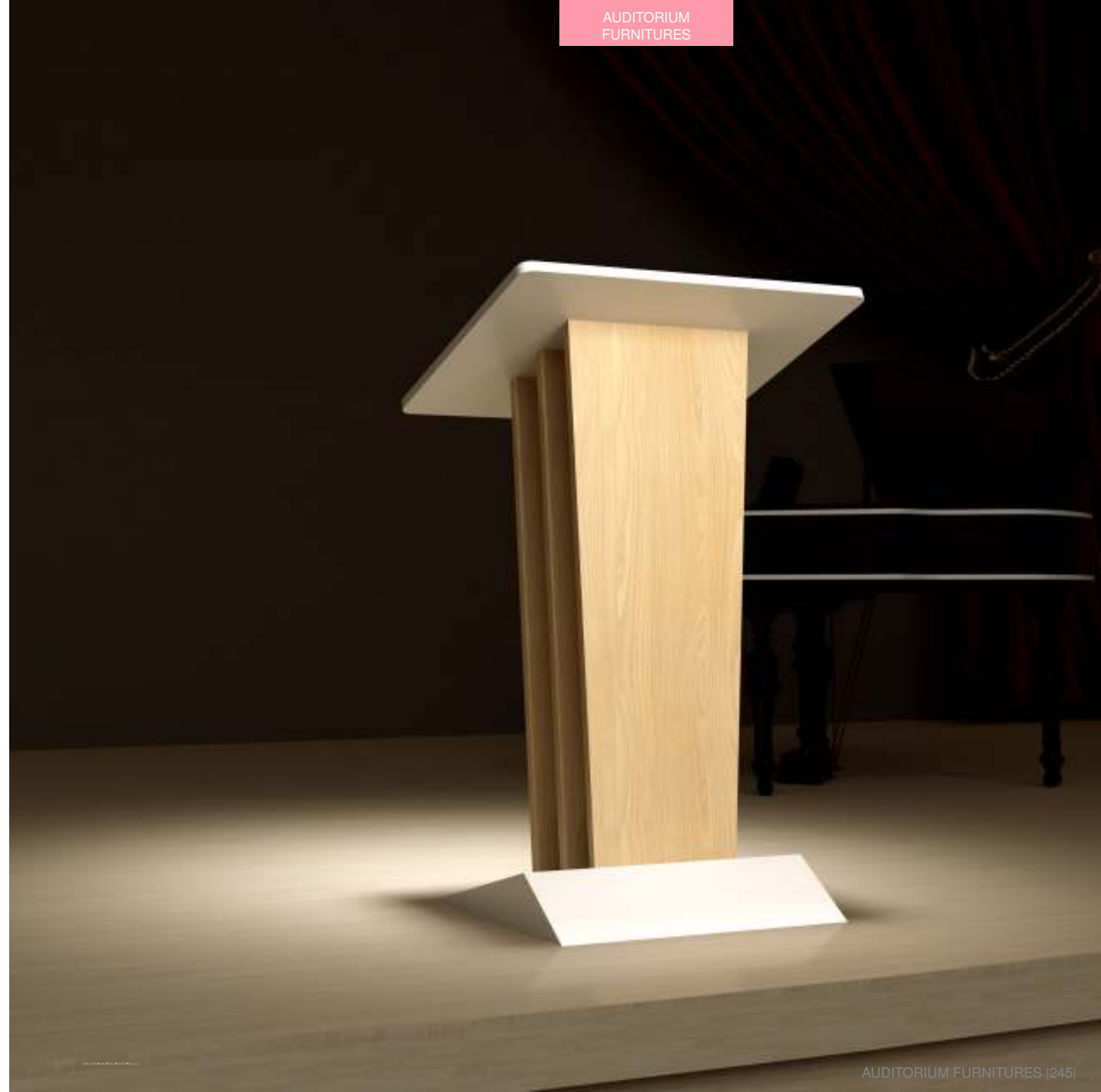

**PODIUM-03 BOXES**



**PODIUM-04 SWAN**



- Structure available in 18mm thick Laminated MDF or 18mm thick MDF with Veneer with natural lacquer finish
- 2mm thick PVC edging for laminated
- Electrical Outlet, Data Outlet & Cable Cover

Size:  
E082C1 Size: 600x600x1000mm  
E082C2 Size: 750x600x1000mm  
E082C3 Size: 1000x600x1000mm

- Structure available in 18mm thick Laminated MDF or 18mm thick MDF with Veneer with natural lacquer finish
- 2mm thick PVC edging for laminated
- Electrical Outlet, Data Outlet & Cable Cover

Size:  
E082D1 Size: 600x600x1000mm  
E082D2 Size: 750x600x1000mm  
E082D3 Size: 1000x600x1000mm





# LABORATORY FURNITURES

E Series .....	236
System 1 .....	240
System 2 .....	244
System 3 .....	250
Laboratory Miscellaneous .....	256

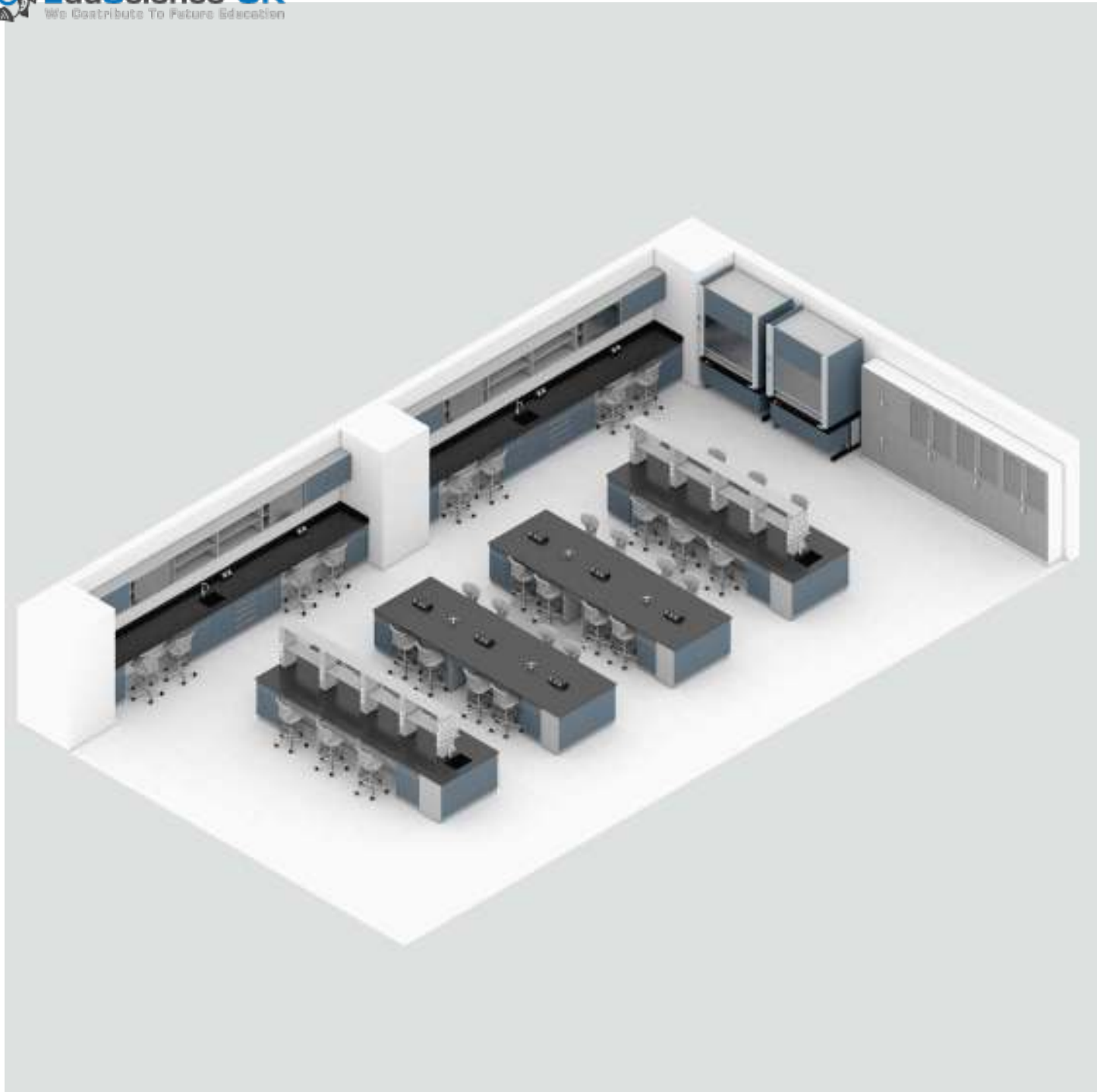

**E SERIES**

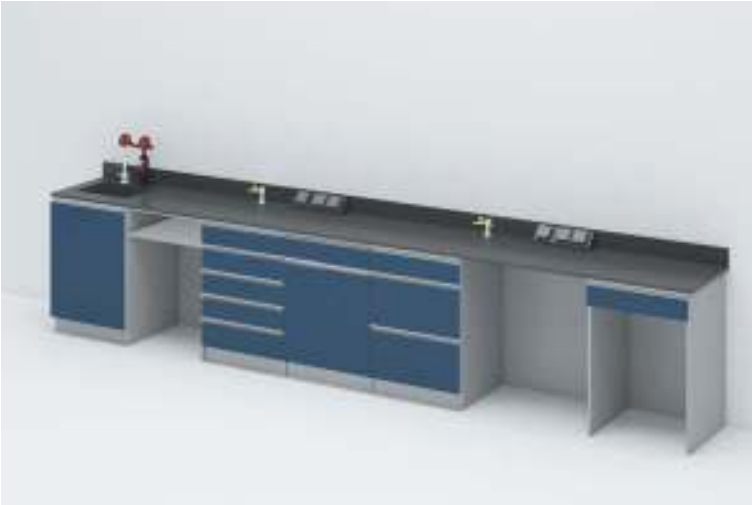

**WALL BENCH**

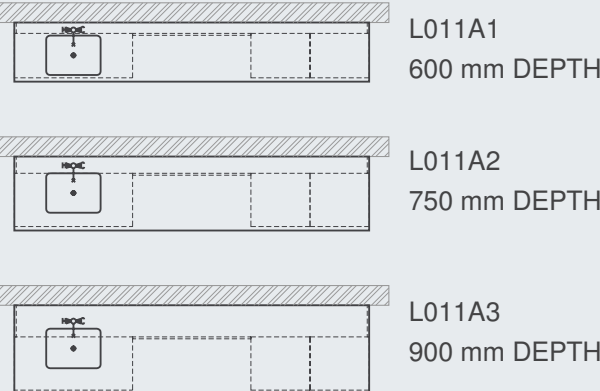

**ISLAND BENCH**

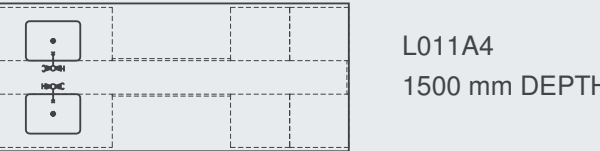





## E SERIES

### GENERAL SPECIFICATION

#### WORKTOP & SINK

To be selected to suit the application  
Worktops are mounted on Cabinets / Panels

#### SERVICES

To be selected to suit the application

#### SERVICE CHANNEL

Any EduScience standard service channel system can be used

#### COLOUR SCHEME

As per client choice

### CABINETRY

All Cabinets are mounted on pedestal of 100mm height  
Standard Dimension as per enclosed list

#### CORE MATERIALS

Standard material are Water Boiled Proof (WBP) Furniture  
Grade Plywood.

(Optional) Mild Steel Sheet, Stainless Steel Sheet as per  
client choice

Custom made which is non standard materials are possible  
as per client requirement.

Cabinet Body	18mm thick
Door/Drawer Front	18mm thick
Adjustable/Fixed Shelf	18mm thick
Back Wall	6mm thick
Drawer Bottom & Back	12mm thick

#### LAMINATE

Door/Drawer Front & Cabinet Carcass from 0.9mm thick  
High Pressure Decorative Laminate (HPDL) hot pressed  
Back wall & Drawer box from 0.6mm thick High Pressure  
Decorative Laminate (HPDL) hot pressed  
Textured finish, colour as per client choice.

#### EDGING

2mm thick PVC edging, hotmelt glued at 205 degree celsius  
for door & drawer fronts, 0.5mm thick tape edging hotmelt  
glued at 205 degree celcius for hidden part.

#### HINGES

Corrosion proof, clip on, soft closing hinges, opening up to  
170 Degree, adjustable in three directions.

#### HANDLE

Extruded aluminium grabrail, powder coated as per client  
choice of color or Handle Type as per selection

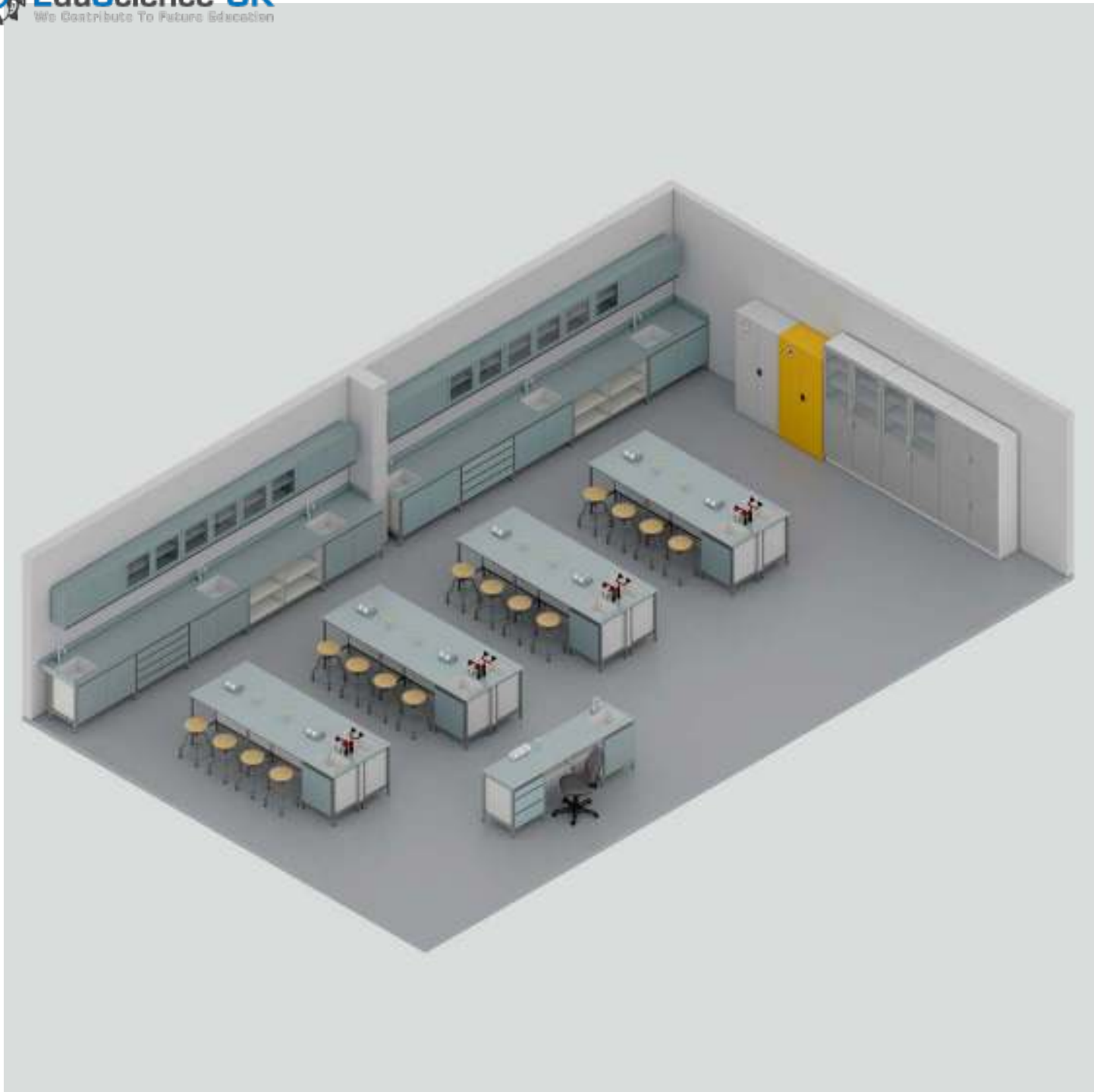

**SYSTEM 1**



**WALL BENCH**



L011B1  
600 mm DEPTH



L011B2  
750 mm DEPTH

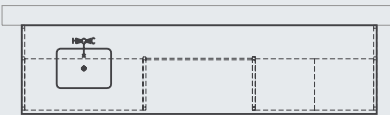

L011B3  
900 mm DEPTH



**ISLAND BENCH**



L011B4  
1500 mm DEPTH





# SYSTEM 1

## GENERAL SPECIFICATION

### WORKTOP & SINK

To be selected to suit the application  
Worktops are placed on the frame works

### SERVICES

To be selected to suit the application

### SERVICE CHANNEL

Any Eduscience standard service channel system can be used

### COLOUR SCHEME

As per client choice

### FRAME WORK

30 x 30 x 2mm thick MS Section with epoxy powder coated.  
Custom made which is non standard materials are possible  
as per client requirements

### ADJUSTABLE FEET

Adjust the height up to 25mm

## CABINETRY

Standard Dimension as per enclosed list

### CORE MATERIALS

Standard material are Water Boiled Proof (WBP) Furniture  
Grade Plywood.

(Optional) Mild Steel Sheet, Stainless Steel Sheet as per  
client choice

Custom made which is non standard materials are possible  
as per client requirement.

Cabinet Body	18mm thick
Door/Drawer Front	18mm thick
Adjustable/Fixed Shelf	18mm thick
Back Wall	6mm thick
Drawer Bottom & Back	12mm thick

### LAMINATE

Door/Drawer Front & Cabinet Carcass from 0.9mm thick  
High Pressure Decorative Laminate (HPDL) hot pressed  
Back wall & Drawer box from 0.6mm thick High Pressure  
Decorative Laminate (HPDL) hot pressed  
Textured finish, colour as per client choice.

### EDGING

2mm thick PVC edging, hotmelt glued at 205 degree celsius  
for door & drawer fronts, 0.5mm thick tape edging hotmelt  
glued at 205 degree celcius for hidden part.

### HINGES

Corrosion proof, clip on, soft closing hinges, opening up to  
170 Degree, adjustable in three directions.

### HANDLE

Extruded aluminium grabrail, powder coated as per client  
choice of color or Handle Type as per selection



**SYSTEM 2**



**WALL BENCH**

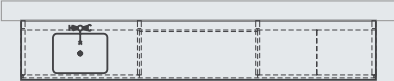

L011C1  
600 mm DEPTH

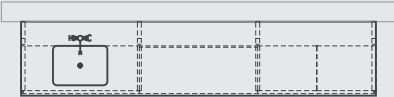

L011C2  
750 mm DEPTH



L011C3  
900 mm DEPTH



**ISLAND BENCH**

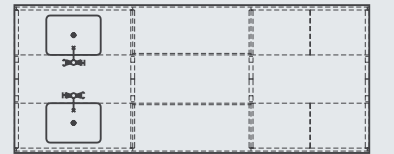

L011C4  
1500 mm DEPTH





## SYSTEM 2

### GENERAL SPECIFICATION

#### WORKTOP & SINK

To be selected to suit the application  
Worktops are placed on the frame work

#### SERVICES

To be selected to suit the application

#### SERVICE CHANNEL

Any EduScience standard service channel system can be used

#### COLOUR SCHEME

As per client choice

#### FRONT / BACK FRAME

X - Front Frame                      60 x 40 x 2mm MS Section  
X & Y - Back Frame                25 x 25 x 2mm MS Angle  
Custom made which is non standard materials are possible as per client requirement.

#### CANTILEVER FRAME

X - Top & Bottom Frame            60 x 30 x 2mm MS Section  
Y - Vertical Frame                    60 x 30 x 2mm MS Section  
Custom made which is non standard materials are possible as per client requirement.

#### ADJUSTABLE FEET

Adjust the height up to 25mm

### CABINETRY

Fixed under bench cabinets suspended on the frame. Standard dimension as per enclosed list.  
Sliding under bench cabinet except the sink units also available as per client choice.

#### CORE MATERIALS

Standard material are Water Boiled Proof (WBP) Furniture Grade Plywood.  
(Optional) Mild Steel Sheet, Stainless Steel Sheet as per client choice  
Custom made which is non standard materials are possible as per client requirement.

Cabinet Body	18mm thick
Door/Drawer Front	18mm thick
Adjustable/Fixed Shelf	18mm thick
Back Wall	6mm thick
Drawer Bottom & Back	12mm thick

#### LAMINATE

Door/Drawer Front & Cabinet Carcass from 0.9mm thick High Pressure Decorative Laminate (HPDL) hot pressed  
Back wall & Drawer box from 0.6mm thick High Pressure Decorative Laminate (HPDL) hot pressed  
Textured finish, colour as per client choice.

#### EDGING

2mm thick PVC edging, hotmelt glued at 205 degree celsius for door & drawer fronts, 0.5mm thick tape edging hotmelt glued at 205 degree celcius for hidden part.

#### HINGES

Corrosion proof, clip on, soft closing hinges, opening up to 170 Degree, adjustable in three directions.

#### HANDLE

Extruded aluminium grabrail, powder coated as per client choice of color or Handle Type as per selection





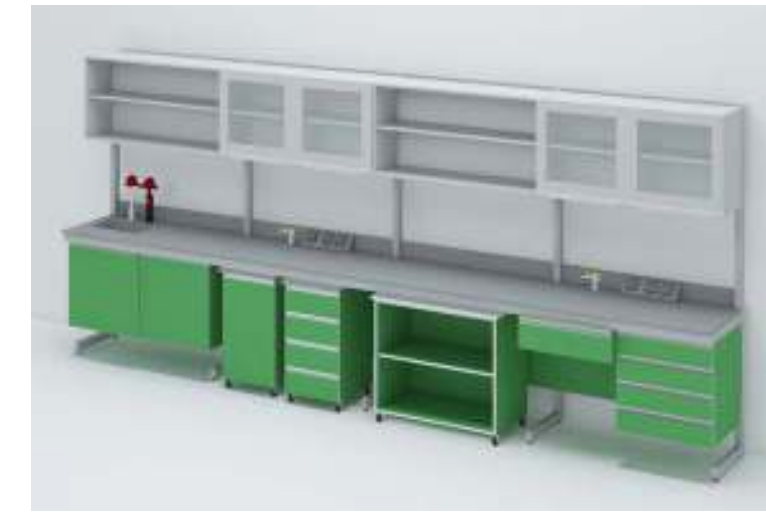

### SYSTEM 3



#### WALL BENCH

	L011D1 600 mm DEPTH
	L011D2 750 mm DEPTH
	L011D3 900 mm DEPTH

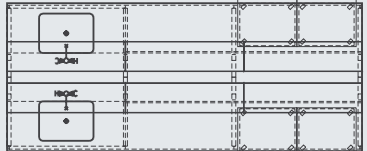

#### ISLAND BENCH

	L011D4 1500 mm DEPTH
---	-------------------------

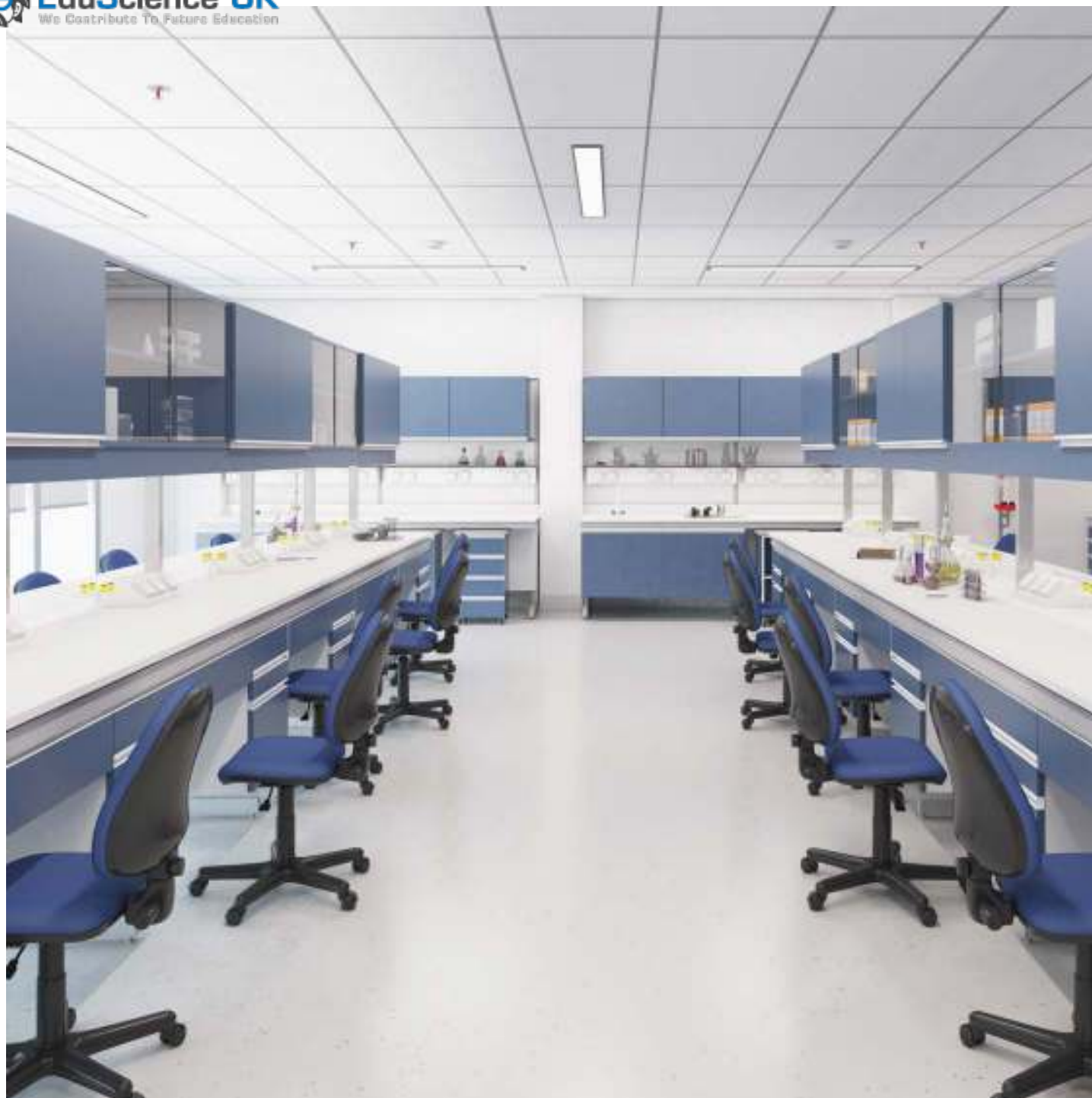

## SYSTEM 3

### GENERAL SPECIFICATION

#### WORKTOP & SINK

To be selected to suit the application  
Worktops are placed on the frame work

#### SERVICES

To be selected to suit the application

#### SERVICE CHANNEL

Any EduScience standard service channel system can be used

#### COLOUR SCHEME

As per client choice

#### FRONT / BACK FRAME

X - Front Frame 60 x 40 x 2mm MS Section  
X & Y - Back Frame 25 x 25 x 2mm MS Angle  
Custom made which is non standard materials are possible as per client requirement.

#### CANTILEVER FRAME

X - Top & Bottom Frame 60 x 30 x 2mm MS Section  
Y - Vertical Frame 60 x 30 x 2mm MS Section  
Custom made which is non standard materials are possible as per client requirement.

#### ADJUSTABLE FEET

Adjust the height up to 25mm

### CABINETRY

Castor mounted trolley units, except sink units  
Standard dimensions as per enclosed list

#### CORE MATERIALS

Standard material are Water Boiled Proof (WBP) Furniture Grade Plywood.

(Optional) Mild Steel Sheet, Stainless Steel Sheet as per client choice

Custom made which is non standard materials are possible as per client requirement.

Cabinet Body	18mm thick
Door/Drawer Front	18mm thick
Adjustable/Fixed Shelf	18mm thick
Back Wall	6mm thick
Drawer Bottom & Back	12mm thick

#### LAMINATE

Door/Drawer Front & Cabinet Carcass from 0.9mm thick High Pressure Decorative Laminate (HPDL) hot pressed  
Back wall & Drawer box from 0.6mm thick High Pressure Decorative Laminate (HPDL) hot pressed  
Textured finish, colour as per client choice.

#### EDGING

2mm thick PVC edging, hotmelt glued at 205 degree celsius for door & drawer fronts, 0.5mm thick tape edging hotmelt glued at 205 degree celcius for hidden part.

#### HINGES

Corrosion proof, clip on, soft closing hinges, opening up to 170 Degree, adjustable in three directions.

#### HANDLE

Extruded aluminium grabrail, powder coated as per client choice of color or Handle Type as per selection



E-SERIES

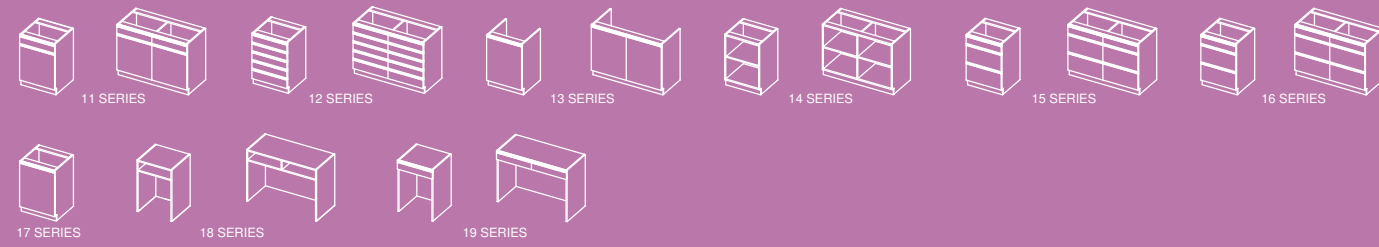

SYSTEM - I

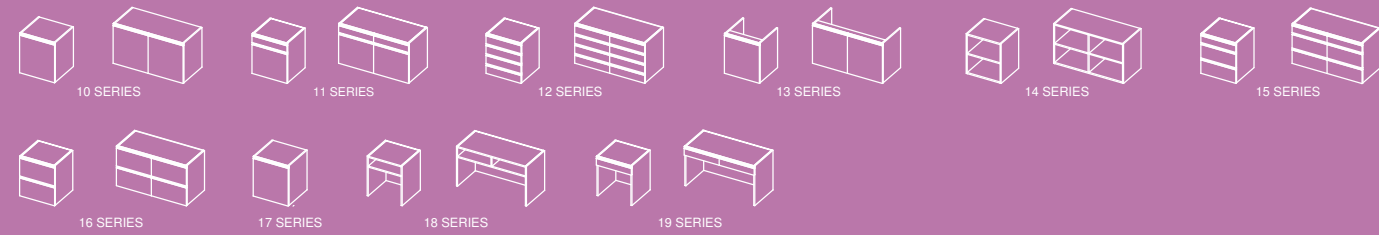

SYSTEM - II

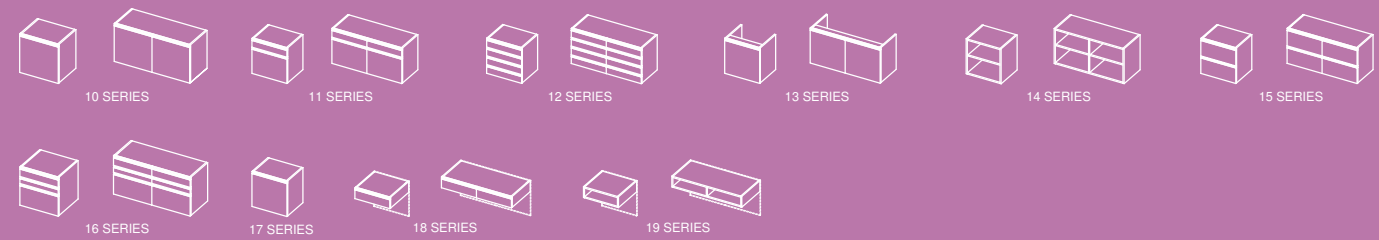

SYSTEM - III



# LAB STORAGE

TALL STORAGE CABINET

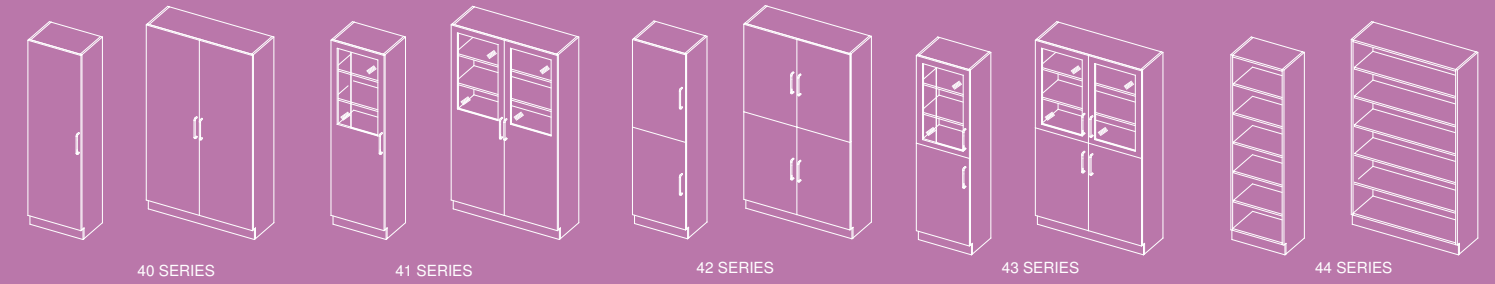

WALL MOUNTED CABINETS

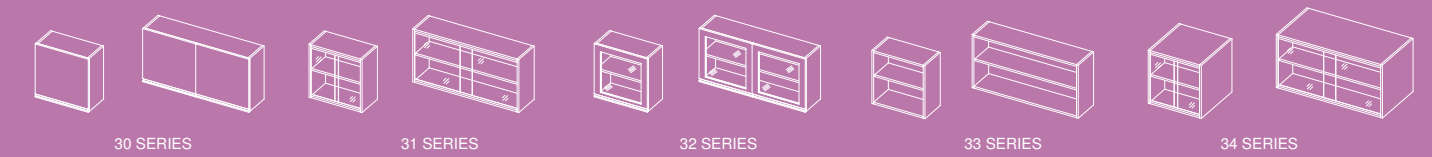

LAORATORY MISCELLANEOUS

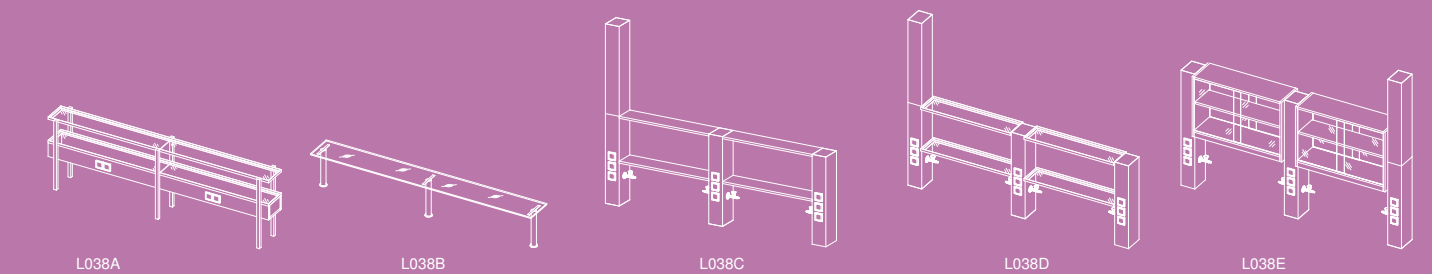

LAORATORY MISCELLANEOUS

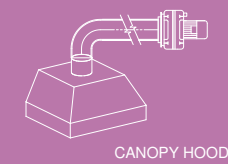

### CIRCULAR DOUBLE TYPE A

L021A



- Technical details as per General specification to suit client needs

Size:  
L021A1- 4836x1500x900mm

### CIRCULAR DOUBLE TYPE B

L021B



- Technical details as per General specification to suit client needs

Size:  
L021B1- 4836x1500x900mm

### CIRCULAR SINGLE TYPE A

L022A



- Technical details as per General specification to suit client needs

Size:  
L022A1-1500x1500x900mm

### HEXAGON DOUBLE TYPE A

L023A



- Technical details as per General specification to suit client needs

Size:  
L023A1-3598x1500x900mm



## HEXAGON SINGLE TYPE A

L024A



- Technical details as per General specification to suit client needs

Size:  
L024A1-1400x1212x900mm

## HEXAGON SINGLE TYPE B

L024B



- Technical details as per General specification to suit client needs

Size:  
L024B1-1500x1299x900mm

## HEXAGON SINGLE TYPE C

L024C



- Technical details as per General specification to suit client needs

Size:  
L024C1-1400x1212x900mm

## HEXAGON SINGLE TYPE D

L024D



- Technical details as per General specification to suit client needs

Size:  
L024D1-1500x1299x900mm

## OCTAGON DOUBLE TYPE A

L025A



- Technical details as per General specification to suit client needs

Size:  
L025A1-3800x1500x900mm

## OCTAGON DOUBLE TYPE B

L025B



- Technical details as per General specification to suit client needs

Size:  
L025B1-4000x1500x900mm

## OCTAGON SINGLE TYPE A

L026A



- Technical details as per General specification to suit client needs

Size:  
L026A1-1500x1500x900mm

## OCTAGON SINGLE TYPE B

L026B



- Technical details as per General specification to suit client needs

Size:  
L026B1-1500x1500x900mm



## OCTAGON SINGLE TYPE C

L026C



- Technical details as per General specification to suit client needs

Size:  
L026C1-1500x1500x900mm

## OCTAGON SINGLE TYPE D

L026D



- Technical details as per General specification to suit client needs

Size:  
L026D1-1500x1500x900mm

## SQUARE TYPE A

L027A



- Technical details as per General specification to suit client needs

Size:  
L026A1-1500x1500x900mm

## SQUARE TYPE B

L027B



- Technical details as per General specification to suit client needs

Size:  
L026B1-1500x1500x900mm



# STUDENT BENCH

## GENERAL SPECIFICATION

### WORKTOP & SINK

To be selected to suit the application  
Worktops are placed on the frame work

### SERVICES

To be selected to suit the application

### SERVICE CHANNEL

Any EduScience standard service channel system can be used

### FRAME WORK

30 x 30 x 2mm thick MS Section with epoxy powder coated,  
bolted and fixed on the floor

Custom made which is non standard materials are possible  
as per client requirement.

### COLOUR SCHEME

As per client choice

## CABINETRY

All Cabinets are mounted on pedestal of 100mm height  
Standard Dimension as per enclosed list

### CORE MATERIALS

Standard material are Water Boiled Proof (WBP) Furniture  
Grade Plywood.

(Optional) Mild Steel Sheet, Stainless Steel Sheet as per  
client choice

Custom made which is non standard materials are possible  
as per client requirement.

Cabinet Body	18mm thick
Door/Drawer Front	18mm thick
Adjustable/Fixed Shelf	18mm thick
Back Wall	6mm thick
Drawer Bottom & Back	12mm thick

### LAMINATE

Door/Drawer Front & Cabinet Carcass from 0.9mm thick  
High Pressure Decorative Laminate (HPDL) hot pressed  
Back wall & Drawer box from 0.6mm thick High Pressure  
Decorative Laminate (HPDL) hot pressed  
Textured finish, colour as per client choice.

### EDGING

2mm thick PVC edging, hotmelt glued at 205 degree celsius  
for door & drawer fronts, 0.5mm thick tape edging hotmelt  
glued at 205 degree celcius for hidden part.

### HINGES

Corrosion proof, clip on, soft closing hinges, opening up to  
170 Degree, adjustable in three directions.

### HANDLE

Extruded aluminium grabrail, powder coated as per client  
choice of color or Handle Type as per selection



## LAB MISCELLANEOUS

### ACID CABINET

L031A



- Body from 1.2mm thick Mild steel sheet powder coated
  - With rockwool fire retardant internal filling
  - Textured finish chemical & fire resistant powder coating
  - Single / Double door with adjustable shelf and heavy duty locking system
- Country of Origin: U.A.E

Size:

- L031A1: 350x300x700mm
- L031A2: 900x460x700mm
- L031A3: 900x460x900mm
- L031A4: 900x460x1200mm
- L031A5: 900x460x1800mm

### HAZARDOUS CABINET

L032A



- Body from 1.2mm thick Mild steel sheet powder coated
  - With rockwool fire retardant internal filling
  - Textured finish chemical & fire resistant powder coating
  - Single / Double door with adjustable shelf and heavy duty locking system
- Country of Origin: U.A.E

Size:

- L032A1: 350x300x700mm
- L032A2: 900x460x700mm
- L032A3: 900x460x900mm
- L032A4: 900x460x1200mm
- L032A5: 900x460x1800mm

### FUME CUPBOARD

#### CHAMBER UNIT

The unit outer liner is melamine laminated plywood with internal liner of compact laminate for corrosion and chemical resistant. Back baffle is shaped from 9mm thick compact laminate. Inside hood is illuminated by 2 tubes fluorescent lighting, IP56. Front fascia are fixed with electrical sockets, water & gas outlets. Air flow monitor is provided & used for air velocity reading, fan, socket & light switch control. Airfoil in mild steel epoxy coated is fixed in front for smooth air passing. PVC exhaust collar located above hood along with electrical control box.

#### FRONT SASH

The vertical sliding sash door is from 6mm thick tempered glass with counter weight pulley system for easy opening & closing movement.

#### WORKTOP

Chemical resistant worktop is made from 19mm thick solid epoxy, dished on edges for spill control. A cup sink made from polypropylene is also provided.

#### STORAGE CABINET

The chemical storage under bench cabinet is made from melamine laminated plywood with internal liner of compact laminate. Door shutter is with epoxy coated aluminum grab rail handle.

#### BASE FRAME

Heavy duty cantilever frame in ES System II is made from mild steel epoxy powder coated & treated against corrosion. It is fixed with adjustable feet to meet floor levelling and the frame is designed to meet accessibility of any services required behind hood.

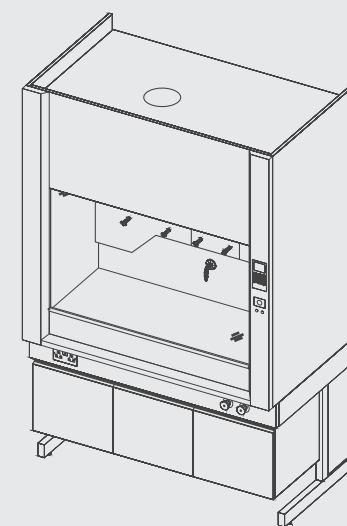

General Specifications of AMI Fume Cupboard				
Model	AMI FC - 120	AMI FC - 150	AMI FC - 180	AMI FC - 240
Nominal Size	1.2 meter (4')	1.5 meter (5')	1.8 meter (6')	2.4 meter (8')
External Dimension	1200x900x1540 mm	1500x900x1540 mm	1800x900x1540 mm	2400x900x1540 mm
Exhaust Diameter	250mm			
Number of Exhaust Collar	1	1	1	2
Fluorescent Lighting System	Prewired hood lighting with electronic ballast for energy efficiency and instant start.			
Lighting Intensity	930 lux	915 lux	886 lux	931 lux
Controller	AMI air flow monitoring system			
Chamber Outer Liner	Melamine laminated plywood			
Chamber Internal Liner	Compact Laminate			
Worktop	19mm thick Solid Epoxy, dished for spill control			
Drip Cup	Polypropylene			
Fittings	Water, Gas, Electrical Outlet			
Sash	6mm thick Tempered Glass			
Sash Configuration	Vertical			
Chamber Nominal Power	100 W ( Lighting )			
L/B Storage Cabinet	Melamine laminated plywood with internal liner of compact laminate			
Base Frame	Heavy duty cantilever mild steel with epoxy powder coating			
Power Requirement	220 Volts, 50Hz			



## TRAY TROLLEY

L033A1



- Top covering from 1.2mm thick Mild steel sheet powder coated
- Frame from 25x25x2mm thick Mild steel tube powder coated
- Swivel castor 75mm dia with 2 breaks diagonally
- 6 nos plastic tray size: 312x427x75mm (F1 Shallow) with plastic runners

Size:  
L033A1-370x450x850mm

## TRAY TROLLEY

L033A2



- Top covering from 1.2mm thick Mild steel sheet powder coated
- Frame from 25x25x2mm thick Mild steel tube powder coated
- Swivel castor 75mm dia with 2 breaks diagonally
- 6 nos plastic tray size: 312x427x75mm (F1 Shallow) with plastic runners

Size:  
L033A2-370x450x725mm

## TRAY TROLLEY

L033B1



- Top covering from 1.2mm thick Mild steel sheet powder coated
- Frame from 25x25x2mm thick Mild steel tube powder coated
- Swivel castor 75mm dia with 2 breaks diagonally
- 12 nos plastic tray size: 312x427x75mm (F1 Shallow) with plastic runners

Size:  
L033B1-715x450x850 mm

## TRAY TROLLEY

L033B2



- Top covering from 1.2mm thick Mild steel sheet powder coated
- Frame from 25x25x2mm thick Mild steel tube powder coated
- Swivel castor 75mm dia with 2 breaks diagonally
- 12 nos plastic tray size: 312x427x75mm (F1 Shallow) with plastic runners

Size:  
L033B2-715x450x725 mm



## TRAY TROLLEY

L033C1



- Top covering from 1.2mm thick Mild steel sheet powder coated
- Frame from 25x25x2mm thick Mild steel tube powder coated
- Swivel castor 75mm dia with 2 breaks diagonally
- 18 nos plastic tray size: 312x427x75mm (F1 Shallow) with plastic runners

Size:

L033C1-1060x450x850 mm

## TRAY TROLLEY

L033C2



- Top covering from 1.2mm thick Mild steel sheet powder coated
- Frame from 25x25x2mm thick Mild steel tube powder coated
- With height levelling legs
- 34 nos plastic tray size: 312x427x75mm (F1 Shallow) with plastic runners

Size:

L033C2 - 1060x450x725 mm

## TRAY TROLLEY

L033D1



- Top covering from 1.2mm thick Mild steel sheet powder coated
- Frame from 25x25x2mm thick Mild steel tube powder coated
- With height levelling legs
- 34 nos plastic tray size: 312x427x75mm (F1 Shallow) with plastic runners

Size:

L033D1-715x450x850 mm

## TRAY TROLLEY

L033E1



- Top covering from 1.2mm thick Mild steel sheet powder coated
- Frame from 25x25x2mm thick Mild steel tube powder coated
- With height levelling legs
- 51 nos plastic tray size: 312x427x75mm (F1 Shallow) with plastic runners

Size:

L033B2-1060x450x1850 mm

## EMERGENCY SHOWER

L036A

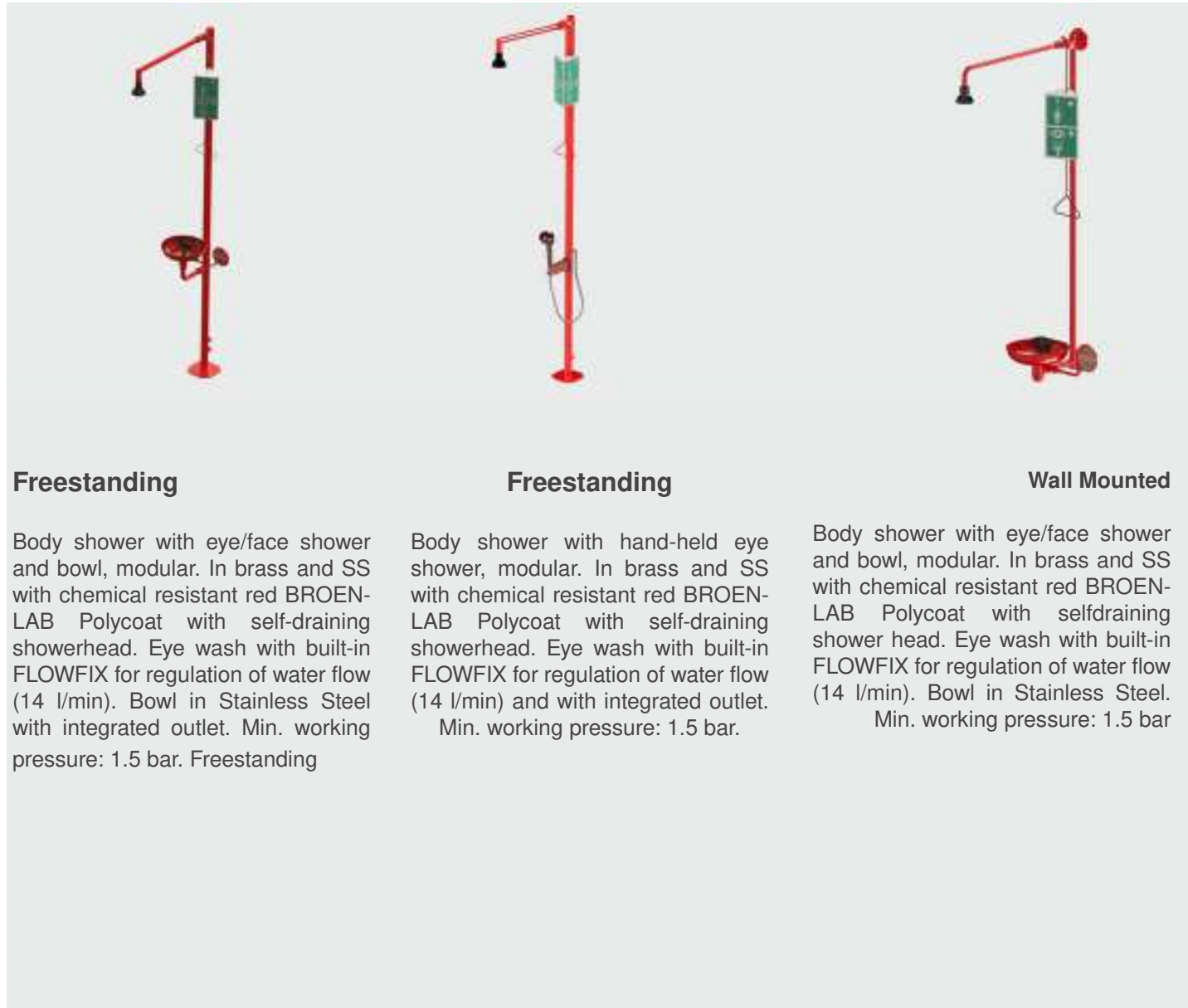

### Freestanding

Body shower with eye/face shower and bowl, modular. In brass and SS with chemical resistant red BROEN-LAB Polycoat with self-draining showerhead. Eye wash with built-in FLOWFIX for regulation of water flow (14 l/min). Bowl in Stainless Steel with integrated outlet. Min. working pressure: 1.5 bar. Freestanding

### Freestanding

Body shower with hand-held eye shower, modular. In brass and SS with chemical resistant red BROEN-LAB Polycoat with self-draining showerhead. Eye wash with built-in FLOWFIX for regulation of water flow (14 l/min) and with integrated outlet. Min. working pressure: 1.5 bar.

### Wall Mounted

Body shower with eye/face shower and bowl, modular. In brass and SS with chemical resistant red BROEN-LAB Polycoat with selfdraining shower head. Eye wash with built-in FLOWFIX for regulation of water flow (14 l/min). Bowl in Stainless Steel. Min. working pressure: 1.5 bar





# CUBICLES

Kids Cubicle. . . . . 266

Basic Cubicle. . . . . 268



## TOILET CUBICLE

E091A



- Structure available in 13mm thick Solid Core HPL that specially made for wet area which are composed of Front Post Panels, Doors & Partitions
- SS grade 304 H/L finish or nylon accessories consist of the following:
  - Handle Knob
  - Lock with Privacy Indicator
  - Hinges with Gravity Self Closing Features
  - Screws with Angle Bracket
  - Coat Hooks
  - Adjustable Feet
  - SS Tissue Holder
  - Headrail Square Type Epoxy Powder Coated
  - H-Connecting Profile Epoxy Powder Coated
  - Sizes as per actual site dimensions

## KIDS TOILET CUBICLE-1

E091B1



- Structure available in 13mm thick Solid Core HPL that specially made for wet area which are composed of Front Post Panels, Doors & Partitions
- SS grade 304 H/L finish or nylon accessories consist of the following:
  - Handle Knob
  - Lock with Privacy Indicator
  - Hinges with Gravity Self Closing Features
  - Screws with Angle Bracket
  - Coat Hooks
  - Adjustable Feet
  - SS Tissue Holder
  - Headrail Square Type Epoxy Powder Coated
  - H-Connecting Profile Epoxy Powder Coated
  - Sizes as per actual site dimensions

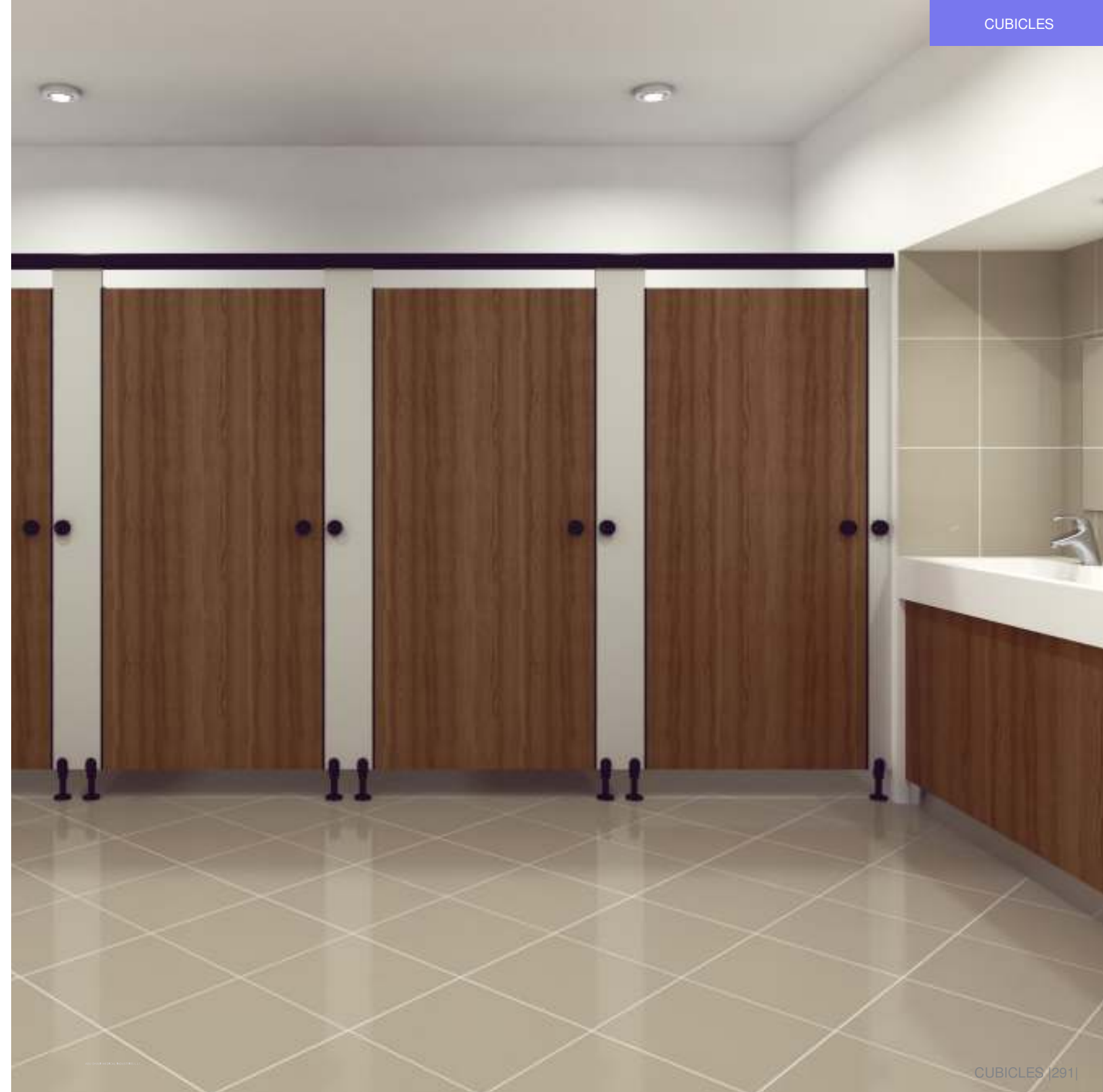





## KIDS TOILET CUBICLE-2

E091B2



- Structure available in 13mm thick Solid Core HPL that specially made for wet area which are composed of Front Post Panels, Doors & Partitions
- SS grade 304 H/L finish or nylon accessories consist of the following:
  - Handle Knob
  - Lock with Privacy Indicator
  - Hinges with Gravity Self Closing Features
  - Screws with Angle Bracket
  - Coat Hooks
  - Adjustable Feet
  - SS Tissue Holder
- Headrail Square Type Epoxy Powder Coated
- H-Connecting Profile Epoxy Powder Coated
- Sizes as per actual site dimensions

## KIDS TOILET CUBICLE-3

E091B3



- Structure available in 13mm thick Solid Core HPL that specially made for wet area which are composed of Front Post Panels, Doors & Partitions
- SS grade 304 H/L finish or nylon accessories consist of the following:
  - Handle Knob
  - Lock with Privacy Indicator
  - Hinges with Gravity Self Closing Features
  - Screws with Angle Bracket
  - Coat Hooks
  - Adjustable Feet
  - SS Tissue Holder
- Headrail Square Type Epoxy Powder Coated
- H-Connecting Profile Epoxy Powder Coated
- Sizes as per actual site dimensions